



## Advanced Surgical Product Catalog



# Mission Statement

Our mission is to **improve the quality of healthcare** by designing, producing, and marketing innovative, high-quality products.

Our emphasis is on patient **safety**, customer **satisfaction**, and sustained growth of shareholder equity.

In pursuit of our goals, we strive to demonstrate **thoughtful leadership**, provide meaningful opportunities for **employees**, and be a responsible member of the global and local communities in which we conduct business.

Ordering Information . . . . . 6

## Access

### AirSeal® System

AirSeal® System . . . . . 10  
 AirSeal® iFS . . . . . 10  
 AirSeal® Filtered Tube Sets . . . . . 10  
 AirSeal® Access Ports . . . . . 10  
 iFS Bottle Gas Connector (Required for bottle gas) . . . . . 10  
 AirSeal® iFS Carts . . . . . 11  
 iFS Valve . . . . . 11  
 iFS Tower . . . . . 11  
 iFS High Pressure Hoses for Bottle Gas . . . . . 11  
 iFS House/Central Gas Connector (Required for house gas) . . . . . 11  
 iFS Low Pressure Hoses for House (Central) Gas International . . . . . 11  
 AirSeal® iFS Miscellaneous Parts and Accessories . . . . . 12  
 iFS Preventative Maintenance and Service Plans . . . . . 12

### BluView Trocars

Optical Trocars . . . . . 13  
 Bladeless Trocars . . . . . 13  
 Bladed Trocars . . . . . 13  
 Blunt Tip Trocars . . . . . 13  
 Universal Cannulas (for use with Optical or Bladed Obturators) . . . . . 13  
 Reusable Thoracoscopy Cannula . . . . . 14

### Insufflation System & Accessories

50L Insufflator . . . . . 15  
 Disposable Insufflation Needles and Tubing/Filter Set Systems . . . . . 15

### AnchorPort® Access Ports

AnchorPort® Access Ports . . . . . 16  
 CORE ENTREE® II Reusable Cannula and Disposable Trocar Modular System . . . . . 17

Cannula, Reusable . . . . . 17  
 Cannula with Fascia Threads, Reusable . . . . . 17  
 Trocar Procedure Kits . . . . . 17

### Core Entree® II Trocars

CORE ENTREE® II Trocar Procedure Kits . . . . . 18  
 CORE ENTREE® II Accessories . . . . . 19  
 Open Laparoscopy Adapters . . . . . 19  
 Trocars . . . . . 19

### Core® Gold Series Trocars

Core® Gold Series Disposable Trocar and Cannula . . . . . 20  
 Core® Gold Series Audible Dilating Trocar and Cannula . . . . . 20  
 Core® Gold Series Disposable Trocar and Cannula . . . . . 21

### Detachaport Trocars

DetachaPort Multi-use Reposable Trocars and Accessories . . . . . 22  
 Multi-use Titanium Cannulas . . . . . 22  
 Single-use Seals . . . . . 22  
 Single-use Converters . . . . . 22  
 DetachaPort Multi-use Reposable Trocars and Accessories . . . . . 23  
 Single-use Obturator and Seal Sets . . . . . 23  
 Multi-use Open Entry Obturators . . . . . 23  
 Multi-use Open Entry Wedge . . . . . 23

### Reflex® Trocars

Reflex® Bladed/Shielded Trocar Systems and Accessories . . . . . 24

## Instruments

### VCare® Plus Uterine Manipulators

VCare® Plus . . . . . 28  
 VCare® DX Plus . . . . . 28

## Disposable Laparoscopic Specimen Bags

Anchor Tissue Retrieval System™	29
Disposable Laparoscopic Specimen Bags	30

## MicroLap® Laparoscopic Instruments

MicroLap® Instruments	31
MicroLap® Curved Scissors	31
MicroLap® Maryland Dissector	31
MicroLap® Tapered Forceps	31
MicroLap® Fenestrated Grasping Forceps	31
MicroLap® Clutch Grasping Forceps	31
MicroLap® Allis Grasping Forceps	31
MicroLap® Specialty Instruments	32
MicroLap® Laparoscopes	32
MicroLap® Trocars Cannula	32
Helical Obturator	32
Seal	32
MicroLap® Trocars (with Stop Cock)	32
MicroLap® Cautery	33
Bipolar Cautery	33
Monopolar Cautery	33
Laparoscopic Suturing Instruments	33
Sterilization System for MicroLap® Instruments	33
Sterilization System for MicroLap® Laparoscopes	33

## DetachaTip® Laparoscopic Instruments

DetachaTip® III Laparoscopic Instruments	34
DetachaTip® III Scissors	34
DetachaTip® III Graspers	34
DetachaTip® III Dissectors	34
DetachaTip® III Handle	34
DetachaTip® III Sterilization Trays	34
DetachaTip® II Scissors	35
DetachaTip® II Graspers	35
DetachaTip® II Dissectors	36
DetachaTip® II Handles	36
DetachaTip® II Sterilization Trays	36

## Disposable Hand Instruments

Disposable Laparoscopic Scissors	37
Reflex® Disposable Laparoscopic Scissors	37
Disposable Laparoscopic Scissors	37

## Core™ Suction / Irrigation System

Core™ Suction / Irrigation System	38
Trumpet Styles (Disposable)	38
Core™ Suction / Irrigation	39
Suction Probes (Reusable)	39
Optional Electrodes (Reusable with integrated suction probe)	39

## Universal Plus® Suction / Irrigation

Universal Plus® System	40
Pistol Grip	40
Straight Handle	40

5mm Electrosurgery Electrodes with Suction/Irrigation Optional Stealth ER Eschar Resistant Coating	40
5mm Electrosurgery Electrodes with Suction/Irrigation Optional Stealth ER Eschar Resistant Coating	41
Interchangeable Reusable Stainless Steel Suction/Irrigation Cannulas	41
Interchangeable Disposable Suction/Irrigation Cannulas	41
FloVac 10K pump	41

## Reflex® Series Ligation / Skin Staplers

Reflex® ELC530 Disposable Laparoscopic Clip Applier	42
Maximum Visibility	42
Maximum Control	42
Tissue Lock Clip	42
Reflex® One Skin Staplers	42
Reflex® TL Tissue Lift Skin Stapler	42
Reflex® Extractor	42
Reflex® RHS Re-Loadable Rotating Head Skin Stapler	42

## Specialty Products

Kittner Blunt Dissectors	43
Anti-Fog Kit	43

## Energy

### Surgical Smoke Evacuators

VisiClear® - Surgical Smoke Evacuator	46
EZLink®	46
ViroVac® - Surgical Smoke Evacuator	47
ViroSafe® ViroVac® Filter Designed to fit ViroVac	47
ClearView™ Smoke Evacuation System	47
ClearView™ Smoke Evacuator	47
ClearView™ Accessories	47
PlumeSafe® Turbo - Surgical Smoke Evacuator	48

### Surgical Smoke Evacuation Pencils

#### & Pencil Adapters

PlumePen® Ultra - Surgical Smoke Evacuation Pencils	49
PlumePen® Elite - Surgical Smoke Evacuation Pencils	49
PlumePen® Pro Surgical Smoke Evacuation Pencils	50
SnapEvac™ Surgical Smoke Evacuation Pencils	50
GoldVac® Slim Smoke Evacuation Pencils	51
GoldVac® Smoke Evacuation Pencils	51
GoldVac® Smoke Evacuation Pencils	51
GoldVac® UltraClean® Electrodes	51
ClearVac Smoke Evacuation Pencils	52
Smoke Evacuation Tubing	52
PenAdapt® - Surgical Smoke Evacuation Pencils	53

### Surgical Smoke Evacuation Tubing & Accessories

1/4 in (6.4 mm) Smoke Evacuation Tubing	54
3/8 in (9.5 mm) Smoke Evacuation Tubing	54
7/8 in (22 mm) Smoke Evacuation Tubing	54

1–1/4 in (32 mm) Smoke Evacuation Tubing . . . . .	54
1–3/8 in (35 mm) Erbium: Yag Tubing Kit . . . . .	54
Speculum Tubing . . . . .	55
Pencil Adapter Tubing Set . . . . .	55
7/8 in (22 mm) Tubing with Wand and Sponge Guard . . . . .	55
1–1/4 in (32 mm) Tubing with Wand and Sponge Guard . . . . .	55
1–3/8 in (35 mm) Tubing with Wand and Sponge Guard . . . . .	55
7/8 in (22 mm) Tubing with Adapters . . . . .	56
Reducer Fittings/Adapters . . . . .	56

## Laparoscopic Solutions

PlumePort® ActiV® - Laparoscopic Solutions . . . . .	57
PlumePort® - Laparoscopic Solutions . . . . .	57
PlumePort® SEO - Laparoscopic Solutions . . . . .	58
PlumePort® SEV - Laparoscopic Solutions . . . . .	58
PlumePort® SE - Laparoscopic Solutions . . . . .	58
LaparoVue® Visibility System - Laparoscopic Solutions . . . . .	59

## Laparoscopic Solutions Accessories

VueTip® Trocar Swab Accessory Kit . . . . .	60
EZLink® . . . . .	60
Pneumatic Footswitch . . . . .	60
ViroSafe® Fluid Trap . . . . .	60
Direct Connect Cables . . . . .	60
Y Adapter . . . . .	61
Surgical Laser Masks . . . . .	61
LaseAdapt® SC Contour TRL Hand Piece Adapter . . . . .	61
LaseAdapt® ProFractional Therapy Hand Piece Adapter . . . . .	61
LaseAdapt® Hand Piece Adapter Clips . . . . .	61
Armstand . . . . .	62

## Filters - For Buffalo Filter® Evacuators

ViroSafe® 6 Filter . . . . .	63
ViroSafe® 6 Twin Port Filter . . . . .	63
ViroSafe® Extra Long Life Filter . . . . .	63
ViroSafe® Extra Long Life Twin Port Filter . . . . .	63
ViroSafe® Veterinary Filter . . . . .	64
ViroSafe® Erbium: YAG Filter . . . . .	64
ViroSafe® Erbium: YAG Kit . . . . .	64
Pre-filter . . . . .	64
ViroSafe® Odor / Hair Removal Filter . . . . .	65
ViroSafe® Pre-Filter . . . . .	65
ViroSafe® 12 Filter . . . . .	65
ViroSafe® ViroVac® Filter . . . . .	65
ViroSafe® VisiClear® Filter . . . . .	65

## Filters - For Wall & Portable Suction Systems

BILF150 Multi-Use In-Line Filter . . . . .	66
BILF200 Multi-Use In-Line Filter . . . . .	66

## Filters - For Competitive Replacement

Berchtold TeleVac & TeleVac LT . . . . .	67
Berchtold Phoenix XS or X3 Filter . . . . .	67

StrykeVac 1 & 2 ViroSafe® Filter . . . . .	68
StrykeVac 3 ViroSafe® Filter . . . . .	68
Surgimedics 7/8 in (22 mm) Pre-filter . . . . .	68
TRUMPF ViroSafe® Filter (EasyVac Filter for TRUMPF EasyVac) . . . . .	69
Smoke Evacuator Filter for Stryker® NEPTUNE® 2 and Neptune 369 . . . . .	

## System 5000™

System 5000™ Electrosurgical Unit (ESU) . . . . .	70
System 5000™ ESU . . . . .	70
Mobile Pedestal . . . . .	70
Footswitches . . . . .	70
Basket . . . . .	70
Stacking Adapter . . . . .	70
Manuals / CD . . . . .	70

## System 2450™

System 2450™ Electrosurgical Unit (ESU) . . . . .	71
System 2450™ ESU . . . . .	71
Footswitches . . . . .	71
Stacking Adapter . . . . .	71
Manuals / CD . . . . .	71
Universal ESU Cart . . . . .	71

## HelixAR™ System

HelixAR™ Electrosurgical Generator with Argon Beam Coagulation (ABC®) . . . . .	72
HelixAR™ System . . . . .	72
Footswitches . . . . .	72
Stacking Adapter . . . . .	72

## Dispersive Electrodes

SureFit™ Dual Dispersive Electrodes . . . . .	73
ThermoGard® Plus ABC® Dispersive Electrodes . . . . .	73
ThermoGard® Dispersive Electrodes . . . . .	73
MacroLyte® Dispersive Electrodes . . . . .	73

## ABC® Dissecting Probes

ABC® Dissecting Electrodes . . . . .	74
Compatible ABC® Probes/Handpieces . . . . .	74

## ABC® Laparoscopic Probes

ABC® Handpieces and Laparoscopic Probes . . . . .	75
Hand Control (Disposable) . . . . .	75
Foot Control (Disposable) . . . . .	75
Foot Control Laparoscopic Probes (Disposable) . . . . .	75
Hand Control Laparoscopic Probes (Disposable) . . . . .	75

## Electrosurgical Pencils

GoldLine® Electrosurgical Pencils . . . . .	76
Push Button, Hand Switch Pencils . . . . .	76
Rocker Switch, Hand Switch Pencils . . . . .	76
Foot Control Pencils . . . . .	76
Tip Cleaner . . . . .	76
Reusable Hand Control Pencils . . . . .	77

Pencil Accessories . . . . .	77
ValueBlue™ ElectroSurgical Pencils . . . . .	77
<b>Active Electrodes</b>	
Disposable Stainless Steel Needles . . . . .	78
Disposable Stainless Steel Balls . . . . .	78
Disposable Loops . . . . .	78
Reusable Blades . . . . .	78
Reusable Needles . . . . .	78
Reusable Extender . . . . .	78
Disposable UltraClean® Blades . . . . .	79
Disposable Stainless Steel Blades . . . . .	79
Disposable UltraClean® Needles . . . . .	79
MicroNeedles . . . . .	79
<b>Dispersive Electrodes</b>	
Reusable Dispersive Electrodes . . . . .	80
Reusable Cables (for use with reusable dispersive electrodes) . . . . .	80
Conductive Gel (for use with reusable dispersive electrodes) . . . . .	80
Dispersive Electrode Adapters and Cables . . . . .	80
Disposable Cords . . . . .	81
Reusable Cables . . . . .	81
Footswitch Adapter Active Instrument Adapter – Monopolar . . . . .	81
<b>Electrosurgical Cables &amp; Adapters</b>	
<b>Visualization</b>	
<b>Looking Glass™</b>	
Video System . . . . .	85
Light Source . . . . .	85
Video Cart . . . . .	85
<b>Camera Systems</b>	
IM8000 True HD 3MOS (3-Chip CMOS) Camera Control Unit . . . . .	86
<b>Trinity™ 4K</b>	
All-In-One Integrated 4K Camera System . . . . .	87
<b>3DHD Vision Systems</b>	
3DHD Camera Controller . . . . .	88
3DHD LCD Display . . . . .	88
3DHD Camera Heads . . . . .	88
3DHD 3D Glasses . . . . .	88
Autoclavable Stereo Endoscopes . . . . .	88
Dual Chanel Bariatric . . . . .	88
Dual Channel Standard length . . . . .	88
<b>Light Sources</b>	
LS8000 Direct LED Light Source . . . . .	89
High Definition Compatible Xenon Light Source . . . . .	89

<b>Medical Monitors</b>	
4K Monitors . . . . .	90
HD LED Monitor . . . . .	90
LCD Monitor Covers . . . . .	90
<b>Content Management System &amp; Recorder</b>	
CMS9000 . . . . .	91
USB300 . . . . .	91
<b>Printer</b>	
Sony Full Page Color Printer . . . . .	92
<b>Surgical Video Carts and Accessories</b>	
VP8501 Video Cart . . . . .	93
Monitor arms . . . . .	93
Suction & Irrigation . . . . .	93
CO2 . . . . .	93
Camera accessories . . . . .	93
Foot pedal holder and basket . . . . .	93
Previous VP8500 Monitor Mounts CART . . . . .	93
<b>Laparoscopes</b>	
Ultra High Definition (UHD) Laparoscopes . . . . .	94
5.5mm UHD Autoclavable Laparoscopes . . . . .	94
Standard Length (Working length 325mm) . . . . .	94
Extended Length (Working Length 450mm) . . . . .	94
10mm UHD Autoclavable Laparoscopes . . . . .	94
Standard Length . . . . .	94
Extended Length . . . . .	94
HD Autoclavable Laparoscopes . . . . .	95
5.5mm HD Autoclavable Laparoscopes	
Standard Length (Working length 325mm) . . . . .	95
Extended Length (Working Length 450mm) . . . . .	95
10mm HD Autoclavable Laparoscopes Standard Length . . . . .	95
<b>Light Guides</b>	
Universal Light Guides . . . . .	96
Non-Transparent . . . . .	96
Translucent Blue . . . . .	96
Translucent Blue 90° . . . . .	96
<b>Fittings</b>	
Light Source Fittings . . . . .	97
Scope Fittings . . . . .	97
<b>Sterilization Trays</b>	
Sterilization Trays . . . . .	98
VP100X Sterilization Tray Series . . . . .	98

# Ordering Information

## To Place Your Order

Please contact your local Sales Representative or Sales Office and provide a purchase order number, billing and shipping instructions, terms, product catalog number and description and valid CONMED quotation, and quantity and pricing to one of the following:

## Customer Service Contact

If you encounter a problem or need technical assistance, contact your CONMED Sales Representative or Customer Service. Refer to the Customer Service telephone numbers listed below.

### Belgium

Phone: +32 2 526 84 80  
Email: [belgium@conmed.com](mailto:belgium@conmed.com)

### France

Phone: +33 04 72 47 40 30  
Email: [serviceclients@conmed.com](mailto:serviceclients@conmed.com)

### Germany

Phone: +49 6152-934-0  
Phone: +49 6152-937-124  
Phone: +49 6152-937-123  
Email: [csde@conmed.com](mailto:csde@conmed.com)

### Italy

Phone: +39.02.33929.1  
Email: [info.it@conmed.com](mailto:info.it@conmed.com)

### Nordic

Phone: +46 (0)31 337 90 30  
Email - Sweden: [infoSE@conmed.com](mailto:infoSE@conmed.com)  
Email - Norway: [infoSE@conmed.com](mailto:infoSE@conmed.com)  
Email - Denmark: [CustomerServiceDK@conmed.com](mailto:CustomerServiceDK@conmed.com)  
Email - Finland: [infoFI@conmed.com](mailto:infoFI@conmed.com)

### Spain

Phone: +34 932 064 070  
Email: [atencioncliente@conmed.com](mailto:atencioncliente@conmed.com)

### UK

Phone: +44 01793 787881  
Email: [uksales@conmed.com](mailto:uksales@conmed.com)

### Export

Email: [InternationalCustomerExperience@Conmed.com](mailto:InternationalCustomerExperience@Conmed.com)

## Terms and Conditions

All CONMED products are manufactured and produced in compliance with the following quality system standards:

21CFR 820, US FDA Quality System Regulation  
CMDCAS  
ISO13485

European MDD, Annex II and V

All products may not be available for sale in your region. For information on pricing and product availability, please contact your local CONMED representative.

## Limited Service Warranty

For a period of two years following the date of shipment (unless specify otherwise), CONMED Corporation warrants electrosurgical units against any defects in materials or workmanship and will repair or replace (at

CONMED's discretion), the same without charge, provided that routine maintenance, as specified in the service manual, has been performed using replacement parts approved by CONMED. This warranty is void if the product is used in a manner or for purposes other than intended.

Extended warranties are available. Please contact your local CONMED Territory Manager, Customer Service, or Technical Services for more information.

## Return Goods Policy

CONMED products may be returned for credit subject to the following:

Returned products, except products that are obsolete, discontinued, damaged, and specialty products, may be returned within 60 days after date of purchase. 50L Insufflator may be returned within 45 days after date of purchase.

A copy of the invoice number and date of purchase and a Return Authorization Number must accompany the returned goods with the reason for the return stated in writing. Contact CONMED Customer Service for the Return Authorization Number.

All returned goods will be subject to a minimum of 15% restocking charge. The exact amount of credit to be given, if any, will be determined by a Quality Assurance inspection. Sterile packaged products may be returned for credit only if returned in the original, unopened shelf package.

If the return is due to our error in shipping, full credit will be given.

All returns should be addressed as indicated by Return Authorization.

## Extended Service Warranty

Extended warranty agreements for the AirSeal® iFS may be purchased at any time – before, during or after the original warranty expiration.

Extended warranty agreements must be received before the original warranty expiration date of any subject electrosurgical unit.

Customers can maintain the warranty for up to seven years from date of shipment per the agreement terms listed in Option A of the Extended Warranty Form. Customers can also purchase an extended warranty per the terms listed in Option B of the Extended Warranty form.

If product is under warranty, the customer is responsible only for shipping the product to CONMED; CONMED is responsible for shipping the product back to the customer. If the product is out of warranty, the customer is responsible for shipping the product to and from CONMED.

## Quality Policy

CONMED is committed to maintaining a quality system that provides for safe and effective products and services that meet the needs and requirements of our patients, customers, and company stakeholders.

## Quality Service and Repair contacts

### **Belgium**

#### **Linvatec and CONMED Branded Units**

CONMED Linvatec Europe  
W.A. Mozartlaan 3,  
B-1620 Drogenbos, Belgium  
Phone: +32-2-334-0785  
Fax: +32-2-526-0572  
Email: [BrusselsRepairCenter@ConMed.com](mailto:BrusselsRepairCenter@ConMed.com)

### **Germany**

#### **Linvatec and CONMED Branded Units**

CONMED Deutschland GmbH  
Frankfurter Straße 74  
D-64521 Groß-Gerau Germany  
Phone: +49 (0)6152 937 0  
Fax: +49 (0)6152 937 100

### **United Kingdom**

#### **Linvatec and CONMED Branded Units**

CONMED UK Ltd.  
73/74 Shrivenham Hundred Business Park  
Swindon, Wiltshire  
SN6 8TY U.K.  
REPAIR CENTER  
Phone: 44-179-378-7910  
[ukservice@conmed.com](mailto:ukservice@conmed.com)



ACCESS





AirSeal® iFS

# AirSeal® System



AS-iFS2



ASM-EVAC1

SEM-EVAC

SIM-TUB



iAS5-75LP



iAS5-100LP



iAS5-120LP



iASB5-150



iAS8-100LP



iAS8-120LP



iAS12-100LPi



iASB12-100



iAS12-120LPi



iASB12-120



iAS12-150

## AirSeal® System

The AirSeal® iFS is the World's first "3 in 1" access management system and features unmatched capabilities in providing a stable pneumoperitoneum, constant smoke evacuation and valve-free access.

## AirSeal® iFS

AirSeal® iFS, 230V ..... AS-iFS2

## AirSeal® Filtered Tube Sets

The AirSeal® iFS is capable of operating in three distinct modes, each of which uses a specific filtered tube set to maximize system performance.

For use with iFS AirSeal® Mode

Tri-Lumen Filtered Tube Set, 6/Box ..... ASM-EVAC1

For use with iFS Smoke Evacuation Mode

Bifurcated Smoke Evac Filtered Tube Set, 6/Box ..... SEM-EVAC

For use with iFS Standard Insufflation Mode,

Single Lumen Filtered Tube Set, 10/Box ..... SIM-TUB

## AirSeal® Access Ports

- Valve-free access to abdominal cavity

- Intact specimen removal

5mm Access Port and Low Profile Obturator with

Bladeless Optical Tip, 75mm Length, 6/Box ..... iAS5-75LP

5mm Access Port and Low Profile Obturator with

Bladeless Optical Tip, 100mm Length, 6/Box ..... iAS5-100LP

5mm Access Port and Low Profile Obturator with

Bladeless Optical Tip, 120mm Length, 6/Box ..... iAS5-120LP

5mm Smooth Access Port with Blunt Tip, 150mm Length

(for use with single site surgical platforms), 6/Box ..... iASB5-150

8mm Access Port and Low Profile Obturator, with

Bladeless Optical Tip, 100mm Length, 6/Box ..... iAS8-100LP

8mm Access Port and Low Profile Obturator, with

Bladeless Optical Tip, 120mm Length, 6/Box ..... iAS8-120LP

12mm Access Port and Palm Grip Obturator, with

Bladeless Optical Tip, 100mm Length, 6/Box ..... iAS12-100LPi

12mm Access Port and Obturator, with Blunt Tip,

100mm Length, 6/Box ..... iASB12-100

12mm Access Port and Palm Grip Obturator, with

Bladeless Optical Tip, 120mm Length, 6/Box ..... iAS12-120LPi

12mm Access Port and Obturator, with Blunt Tip,

120mm Length, 6/Box ..... iASB12-120

12mm Access Port and Obturator with Bladeless

Optical Tip, 150mm Length, 6/Box ..... iAS12-150

## iFS Bottle Gas Connector (Required for bottle gas)

Required Connector

Must be installed on the iFS (37° flare fitting) ..... iFS-BC1

**AirSeal® iFS Carts**

- Cart with Bottle Rack, Holds Two “E” Size CO2 Tank..... AS-iCART
- Cart with Bottle Rack, Holds Two “E” Size CO2 Tanks, Switching Valve and Hoses included ..... AS-iCART-V
- Cart with Bottle Rack, Holds Two “E” Size CO2 Tanks, and Two Mid-Bottle Bracket Supports, and Switching Valve ..AS-iCART-V2R
- Cart with Bottle Rack, Holds Two 6” (160mm) Bottle Gas Tanks..... AS-iCART-6
- Cart with Bottle Rack, Holds Two 6” (160mm) Bottle Gas Tanks, and Switching Valve ..... AS-iCART-6V

**iFS Valve**

- Switching Valve, (2) Yoke Pin Index with 18” Supply Hoses, (1) 36” Connection Hose, (1) 90° Swivel, (1) Mounting Bracket..... iFS-Valve1

**iFS Tower**

- (1) Yoke Pin Index mounted Switching Valve, (1) Yoke Pin Index with 18” Supply Hose and (1) 36” Connection Hose, (1) 90° Swivel ..... iFS-Tower1
- Add-on: 120” High Pressure Hose to “E” Size CO2 Tanks.. iFS-HPH120

**iFS High Pressure Hoses for Bottle Gas**

- 1.5m High Pressure Hose with a Pin Index Yoke to connect to “E” Size CO2 Tanks with a DIN Bottle Gas Tanks ..... iFS-HPH2
- 1.5m High Pressure Hose with a Pin Index Yoke to connect to “E” Size CO2 Tanks with an ISO Bottle Gas Tanks ..... iFS-HPH3
- 36” High Pressure Hose with a Pin Index Yoke to connect to “E” Size CO2 Tanks with a Pin Index Cylinder Valve..... iFS-HPH4

**iFS House/Central Gas Connector (Required for house gas)**

- Required Connector: Must be installed on the iFS
- DISS Fitting..... iFS-WC1
- NIST Fitting (International)..... iFS-WC2

**iFS Low Pressure Hoses for House (Central) Gas International**

- 3m Low Pressure Hose to connect to a NF Wall Connection with iFS-WC2 Connector.....SGQ-588CE
- 5m Low Pressure Hose to connect to a NF Wall Connection with iFS-WC2 Connector.....SGQ-589CE
- 3m Low Pressure Hose to connect to a UNI Wall Connection with iFS-WC2 Connector.....SGQ-590CE
- 5m Low Pressure Hose to connect to a UNI Wall Connection with iFS-WC2 Connector.....SGQ-591CE
- 3m Low Pressure Hose to connect to a DIN Wall Connection with iFS-WC2 Connector .....SGQ-592CE
- 5m Low Pressure Hose to connect to a DIN Wall Connection with iFS-WC2 Connector .....SGQ-593CE



AS-iCART



iFS-HPH4



iFS-HPH2



iFS-HPH3



NF



UNI



DIN



AGA

3m Low Pressure Hose to connect to a  
AGA Wall Connection with iFS-WC2 Connector .....SGQ-594CE

5m Low Pressure Hose to connect to a  
AGA Wall Connection with iFS-WC2 Connector .....SGQ-595CE

**AirSeal® iFS Miscellaneous Parts and Accessories**

iFS Fuse, 10 Amp ..... iFS-Fuse

iFS Connector O-Ring..... iFS-ORING

Pin Index Yoke Seal, 10 Pack ..... iFS-SEAL

Connector for High Pressure Gas Hose ..... iFS-CON1

Upper Gas Bottle Assembly for use on -2R Carts.....SQ-22213

Switching Valve for Low Pressure House Gas ..... iFS-HGSV

160mm Bottle Rack Base for use on -6 Carts .....SQ-85601038

Pin Index Yoke JIC Male..... SGQ-545

Pin Index Yoke 1/4 NPT Male .....SCG-547

Valve Bracket for use on -V Carts and -2R Carts ..... iCART-BRACKET

**iFS Preventative Maintenance and Service Plans**

2 Year Preventative Maintenance ..... iFS-2PM

12 Month Service Plan ..... iFS-SP12

24 Month Service Plan ..... iFS-SP24

36 Month Service Plan ..... iFS-SP36

48 Month Service Plan ..... iFS-SP48

### BluView Trocars

Single use, disposable trocar

### Optical Trocars

- 5mm Trocar and Cannula, 70mm Length..... BV-5X70
- 5mm Trocar and Cannula, 100mm Length..... BV-5X100
- 5mm Obturator and Cannula, 150mm Length..... BV-5X150
- 11mm Obturator and Cannula, 70mm Length..... BV-11X70
- 11mm Trocar and Cannula, 100mm Length..... BV-11X100
- 11mm Obturator and Cannula, 150mm Length..... BV-11X150
- 12mm Obturator and Cannula, 70mm Length..... BV-12X70
- 12mm Trocar and Cannula, 100mm Length..... BV-12X100
- 12mm Obturator and Cannula, 150mm Length..... BV-12X150

### Bladeless Trocars

- 15mm Obturator and Cannula, 100mm Length..... BV-15X100BLS

### Bladed Trocars

- 5mm Trocar and Cannula, 70mm Length..... BV-5X70-BLD
- 5mm Trocar and Cannula, 100mm Length..... BV-5X100-BLD
- 5mm Obturator and Cannula, 150mm Length..... BV-5X150-BLD
- 11mm Trocar and Cannula, 100mm Length..... BV-11X100-BLD
- 11mm Obturator and Cannula, 150mm Length..... BV-11X150-BLD
- 12mm Obturator and Cannula, 70mm Length..... BV-12X70-BLD
- 12mm Trocar and Cannula, 100mm Length..... BV-12X100-BLD
- 12mm Obturator and Cannula, 150mm Length..... BV-12X150-BLD
- 15mm Obturator and Cannula, 100mm Length..... BV-15X100-BLD

### Blunt Tip Trocars

- 11mm Trocar and Cannula, 100mm Length..... BV-11X100-HSS
- 12mm Trocar and Cannula, 100mm Length..... BV-12X100-HSS

### Universal Cannulas (for use with Optical or Bladed Obturators)

- 5mm Cannula, 70mm Length ..... BV-5X70-CAN
- 5mm Cannula, 100mm Length ..... BV-5X100-CAN
- 11mm Cannula, 70mm Length ..... BV-11X70-CAN
- 11mm Cannula, 100mm Length ..... BV-11X100-CAN
- 11mm Cannula, 150mm Length ..... BV-11X150-CAN
- 12mm Cannula, 70mm Length ..... BV-12X70-CAN
- 12mm Cannula, 100mm Length ..... BV-12X100-CAN
- 12mm Cannula, 150mm Length ..... BV-12X150-CAN



BluView



BV-5X100



BV-5X100-BLD



BV-11X100-HSS



BluView



BV-12X100-BLD

## Thoracoscopy Trocars

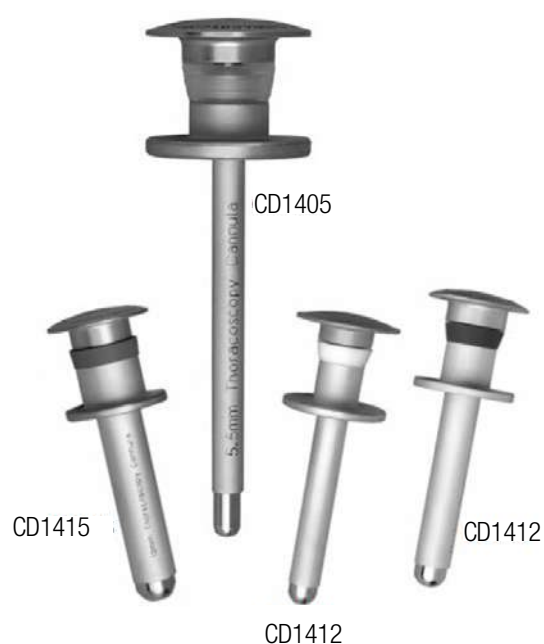

### Reusable Thoracoscopy Cannula

5mm Thorascopic Cannula with Blunt Tip Trocar ..... CD1405  
 60mm length, Multi-use, Non sterile, 1/pkg  
 (Uses Seal CD155 or CD 155B. Sold separately)

10/11mm Thorascopic Cannula with Blunt Tip Trocar ..... CD1411  
 60mm length, Multi-use, Non sterile, 1/pkg  
 (Uses Seal CD111 or CD 111B. Sold separately)

10/12mm Thorascopic Cannula with Blunt Tip Trocar ..... CD1412  
 60mm length, Multi-use, Non sterile, 1/pkg  
 (Uses Seal CD112 or CD 112B. Sold separately)

15mm Thorascopic Cannula with Blunt Tip Trocar ..... CD1415  
 60mm length, Multi-use, Non sterile, 1/pkg  
 (Uses Seal CD116 or CD 116B. Sold separately)

### 50L Insufflator

50L Insufflator .....	GS2000
Hose and Yoke for CO <sub>2</sub> , E-Tank, 4' .....	GS1052
DIN477, Hose and Connection for CO <sub>2</sub> Tank .....	GS202K
DISS Hose for "wall" CO <sub>2</sub> 2' .....	GS1053
Dual Tank Shuttle Valve System .....	GS2050
Power Cord, 155 VAC 6' .....	C7104
Power Cord, 230 VAC 10' .....	C7105
CO <sub>2</sub> Warmer, in-line, reusable .....	GS1012
Cleaning Brushes for Warmer assembly, 10/pkg .....	GS1054
Adapter, CPC to IEC (for C7011 tubing .....	GS1050
Adapter, CPC to Luer (for C7010 tubing .....	GS1051
Insufflation Tubing Set, disposable, CPC/Luer, w/filter .....	GS1016
Insufflation Tubing Set, disposable, Luer/Luer, w/filter C7011 tubing requires a GS1050 adapter .....	C7010
Insufflation Tubing Set, disposable, IEC/Luer, w/filter	
CPS Tubing Set, disposable, w/filter .....	GS1013

### Disposable Insufflation Needles and Tubing/Filter Set Systems

Pneumoperitoneum Insufflation Needle, 14 gauge, 12cm, with stainless steel tip guard and band indicator 10/cs .....	60-6050-001
Pneumoperitoneum Insufflation Needle, 14 gauge, 15cm, with stainless steel tip guard and band indicator 10/cs .....	60-6050-002
Insufflation Tubing (10' length) and 0.1 micron hydrophobic filter assembly with suction type connector 10/cs .....	60-6050-097
Insufflation Tubing (10' length) and 0.1 micron hydrophobic filter assembly with "O" ring connector 10/cs .....	60-6050-098
Insufflation Tubing (10' length) and 0.1 micron hydrophobic filter assembly with luer lock connector 10/cs .....	60-6050-099



GS2000



GS1012

## AnchorPort® Access Ports



AP5-75



AP5-75-SILK



APCi5-75



AP5-100



AP5-100-SILK



APCi5-100

### AnchorPort® Access Ports

Automatically self-adjusts to patient's abdominal wall thickness

- Low profile housing
- Self-adjusting elastomeric sheath
- Bladeless tip
- Optical scope lock

AnchorPort® 5mm Trocar w/ Bladeless Optical Tip Obturator and Cannula with Insufflation Port, 75mm Length, 6/Box ..... AP5-75

AnchorPort® 5mm, Single Incision Laparoscopy Kit, 75mm Length, 6/Box ..... AP5-75-SILK

AnchorPort® 5mm Cannula with Insufflation Port, 75mm Length, 12/Box ..... APCi5-75

AnchorPort® 5mm Trocar with Bladeless Optical Tip Obturator and Cannula with Insufflation Port, 100mm Length, 6/Box ..... AP5-100

AnchorPort® 5mm Single Incision Laparoscopy Kit, 100mm Length, 6/Box ..... AP5-100-SILK

AnchorPort® 5mm Cannula with Insufflation Port, 100mm Length, 12/Box ..... APCi5-100



**CORE ENTREE® II Reusable Cannula and Disposable Trocar Modular System**

**Cannula, Reusable**

- 5mm Cannula, 100mm length ..... CD1609
- 7/8mm Cannula, 90mm length ..... CD1607
- 10mm Cannula, 110mm length ..... CD1610
- 10/12mm Cannula, 100mm length ..... CD1612

**Cannula with Fascia Threads, Reusable**

- 5mm Cannula, 55mm length without stopcock ..... CD1605FH
- 5mm Cannula, 55mm length ..... CD1606FH
- 5mm Cannula, 100mm length without stopcock ..... CD1608FH
- 5mm Cannula, 100mm length ..... CD1609FH
- 10mm Cannula, 110mm length ..... CD1610FH
- 10/12mm Cannula, 100mm length ..... CD1612FH

**Trocar Procedure Kits**

- 5mm Trocar Procedure Kit
- 1 each 5mm Trocar, 55mm length,
- 2 each 5mm Cannula Valve Sterile, 10 kits/box..... CD6300P
- 5mm Trocar Procedure Kit
- 1 each 5mm Trocar, 100mm length,
- 2 each 5mm Cannula Valve Sterile, 10 kits/box..... CD6350P
- 5mm Trocar Procedure Kit
- 1 each 5mm Audible Dilating Trocar, 55mm length,
- 2 each 5mm Cannula Valve Sterile, 10 kits/box..... CD7100G
- 5mm Trocar Procedure Kit
- 1 each 5mm Audible Dilating Trocar, 100mm length,
- 2 each 5mm Cannula Valve, Sterile, 10 kits/box..... CD7150G
- 7/8mm Trocar Procedure Kit
- 1 each 7/8mm Audible Dilating Trocar, 90mm length,
- 1 each 5-12mm Valve/Reducer Sterile, 10 kits/box..... CD7308G



## Core Entree® II Trocars



CD7565G



CD775



CD612



CD650

### CORE ENTREE® II Trocar Procedure Kits

#### Lap Chole 5 and 10mm Trocar Procedure Kit

1 each 10mm Audible Dilating Trocar, 110mm length  
 2 each 5-12mm Valve/Reducer, 1 each 5mm Audible Dilating Trocar,  
 100mm length, 2 each 5mm Cannula Valve Sterile,  
 10 kits/box ..... CD7435G

#### 10mm Trocar Procedure Kit

1 each 10mm Audible Dilating Trocar, 110mm length  
 1 each 5-12mm II Valve/Reducer Sterile,  
 10 kits/box ..... CD7465G

#### Lap Chole 5 and 10/12mm Trocar Procedure Kit

1 each 10/12mm Audible Dilating Trocar, 100mm length  
 2 each 5-12mm II Valve/Reducer, 1 each 5mm Trocar,  
 100mm length, 2 each 5mm Cannula Valve Sterile,  
 10 kits/box ..... CD7513G

#### Lap Chole 5 and 10/12mm Trocar Procedure Kit

1 each 10/12mm Audible Dilating Trocar, 100mm length  
 2 each 5-12mm Valve/Reducer,  
 1 each 5mm Audible Dilating Trocar, 100mm length  
 2 each 5mm Cannula Valve Sterile,  
 10 kits/box ..... CD7535G

#### 10/12mm Trocar Single Puncture Procedure Kit

1 each 10/12mm Audible Dilating Trocar, 100mm length  
 1 each 5mm Valve/Reducer Sterile, 10 kits/box ..... CD7565G

10/12mm Audible Dilating Trocar with shield, 100mm length  
 Sterile, 10 each/box ..... CD7012G

10mm Audible Dilating Trocar with shield, 110mm length  
 Sterile, 10 each/box ..... CD7010G

7/8mm Audible Dilating Trocar with shield, 90mm length  
 Sterile, 10 each/box ..... CD7008G

5-12mm Valve/Reducer  
 Sterile, 10 each/box ..... CD775

5/10/12mm Valve/Flip-Top Reducer  
 Sterile, 10 each/box ..... CD612

5mm Cannula Valve  
 Sterile, 10 each/box ..... CD650

**CORE ENTREE® II Accessories**

**Open Laparoscopy Adapters**

Open Laparoscopy Adapter and 5mm Blunt Tip Trocar  
5mm Pediatric, 100mm length, Reusable, 1 each/box ..... CD1402

Open Laparoscopy Adapter and 5mm Blunt Tip Trocar  
5mm Adult, 100mm length, Reusable, 1 each/box ..... CD1404

Open Laparoscopy Adapter and Blunt Tip Trocar  
10/12mm, 100 length, Reusable, 1 each/box ..... CD1406

10mm Fascia Anchor Adapter  
Reusable, 1 each/box ..... CD411

**Trocars**

7/8mm Trocar, 90mm length, Reusable, 1 each/box ..... CD5080P-I

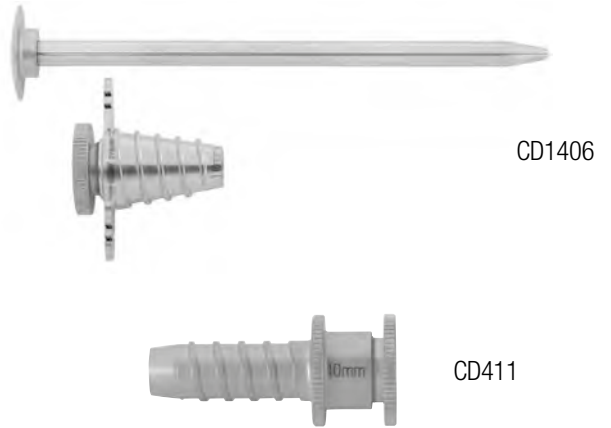

## Core® Gold Series Trocars



Trocar and Cannula



Trocar and Cannula with Stopcock



Audible Dilating Trocar and Cannula



Audible Dilating Trocar and Cannula with Stopcock

### Core® Gold Series Disposable Trocar and Cannula

5mm Trocar and Cannula, 50mm Length (Single Pack) Sterile, 10 each/box .....	CD1705
5mm Trocar and Cannula, 50mm Length (Dual Pack) Sterile, 10 each/box .....	CD1706
5mm Trocar and Cannula with Stopcock, 50mm Length (Single Pack) Sterile, 10 each/box .....	CD1708
5mm Trocar and Cannula, 65mm Length (Single Pack) Sterile, 10 each/box .....	CD1722
5mm Trocar and Cannula, 65mm Length (Dual Pack) Sterile, 10 each/box .....	CD1723
5mm Trocar and Cannula with Stopcock, 100mm Length (Single Pack) Sterile, 10 each/box .....	CD1735

### Core® Gold Series Audible Dilating Trocar and Cannula

5mm Audible Dilating Trocar and Cannula 65mm Length (Single Pack), Sterile, 10 each/box .....	CD1922
5mm Audible Dilating Trocar and Cannula 65mm Length, (Dual Pack), Sterile, 10 each/box .....	CD1923
5mm Audible Dilating Trocar and Cannula with Stopcock 65mm Length, (Single Pack), Sterile, 10 each/box .....	CD1928
5mm Audible Dilating Trocar and Cannula with Stopcock 100mm Length, (Single Pack), Sterile, 10 each/box .....	CD1935
5mm Audible Dilating Trocar and Cannula with Stopcock 100mm Length, (Dual Pack), Sterile, 10 each/box .....	CD1937

**Core® Gold Series Disposable Trocar and Cannula**

- 7/8mm Audible Dilating Trocar and Cannula with Stopcock  
90mm Length, Sterile, 10 each/box ..... CD1940
- 10mm Audible Dilating Trocar and Cannula with Stopcock  
110mm Length, (Single Pack), Sterile, 10 each/box ..... CD1950
- 10/12mm Audible Dilating Trocar and Cannula with Stopcock  
100mm Length, (Single Pack), Sterile, 10 each/box ..... CD1960
- 10/12mm Cannula with Stopcock, 100mm length  
Sterile, 10 each/box ..... CD1961
- 10/12mm Open Laparoscopic Blunt Trocar and Cannula with  
adjustable suture wing, 100mm length Sterile,  
10 each/box ..... CD1982



CD1907



CD1960



CD1961



CD1982

## Detachaport Trocars



### DetachaPort Multi-use Reposable Trocars and Accessories

#### Multi-use Titanium Cannulas

Cannula, 5mm, 70mm length, Non-Sterile .....	1-7001
Cannula, 5mm, 100mm length, Non-Sterile .....	1-7002
Cannula, 10mm, 100mm length, Non-Sterile .....	1-7003
Cannula, 12mm, 100mm length, Non-Sterile .....	1-7005

Threaded Cannula, 5mm, 70mm length, Non-Sterile .....	1-7007
Threaded Cannula, 5mm, 100mm length, Non-Sterile .....	1-7008
Threaded Cannula, 10mm, 100mm length, Non-Sterile .....	1-7009
Threaded Cannula, 12mm, 100mm length, Non-Sterile .....	1-7011

#### Single-use Seals

Seal, 5mm, Each seal includes one stopcock. Sterile, 10/cs .....	1-7013
Seal, 10/12mm diameter with reducer. Each seal includes one stopcock. Sterile, 10/cs .....	1-7044

#### Single-use Converters

UCSII Universal Converter, 5mm, 10/12mm Each seal includes one stopcock. Sterile, 10/cs .....	1-7045
--	--------

## DetachaPort Multi-use Reposable Trocars and Accessories

### Single-use Obturator and Seal Sets

Obturator and Seal Set  
 1 each 5mm obturator (70mm length) and 1 each 5mm seal  
 Sterile, 10/cs.  
 (Each set includes one stopcock for every seal.)..... 1-7016

Obturator and Seal Set  
 1 each 5mm obturator (70mm length) and 2 5mm seals  
 Sterile, 10/cs.  
 (Each set includes one stopcock for every seal.)..... 1-7017

Obturator and Seal Set  
 1 each 5mm obturator (100mm length) and 1 each 5mm seal  
 Sterile, 10/cs.  
 (Each set includes one stopcock for every seal.)..... 1-7018

Obturator and Seal Set  
 1 each 5mm obturator (100mm length) and 2 5mm seals  
 Sterile, 10/cs.  
 (Each set includes one stopcock for every seal.)..... 1-7019

Obturator and Seal Set  
 1 each 10mm obturator (100mm length) and 1 each 10/12mm seal  
 with reducer Sterile, 10/cs.  
 (Each set includes one stopcock for every seal.)..... 1-7020

Obturator and Seal Set  
 1 each 10mm obturator (100mm length) and 2 10/12mm seals  
 with reducers Sterile, 10/cs.  
 (Each set includes one stopcock for every seal.)..... 1-7021

Obturator and Seal Set  
 1 each 12mm obturator (100mm length) and 1 each 10/12mm seal  
 with reducer Sterile, 10/cs.  
 (Each set includes one stopcock for every seal.)..... 1-7024

Obturator and Seal Set  
 1 each 12mm obturator (100mm length) and 2 10/12mm seals  
 with reducers Sterile, 10/cs.  
 (Each set includes one stopcock for every seal.)..... 1-7025

Obturator and Seal Set  
 1 each 12mm obturator (100mm length) and 3 10/12mm seals  
 with reducers Sterile, 10/cs.  
 (Each set includes one stopcock for every seal.)..... 1-7028

### Multi-use Open Entry Obturators

Open Entry Obturator, 12mm, 100mm length,  
 Non-Sterile ..... 1-7055

### Multi-use Open Entry Wedge

Open Entry Trocar Wedge, 12mm, Non-Sterile ..... 1-7057

Open Entry Trocar Wedge  
 Wedge silicone, seal replacement. Non-Sterile, 10/pkg..... 1-7052





16220



16162

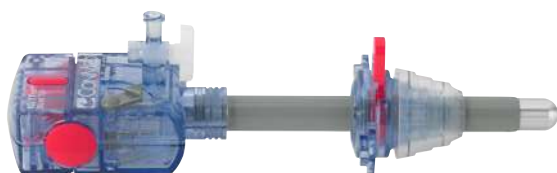

16150



1700



1705

**Reflex® Bladed/Shielded Trocar Systems and Accessories**

Surgical Trocar with Internal Shield, 5mm Single-use, Sterile, 6/cs .....	16050
Surgical Trocar with Internal Shield, 10/11mm Single-use, Sterile, 6/cs .....	16160
Surgical Trocar with Internal Shield, 10/12mm Single-use, Sterile, 6/cs .....	16020
Long Surgical Trocar with Internal Shield, 10/12mm 150mm length, Single-use, Sterile, 6/cs .....	16220
Surgical Trocar Sleeve, 5mm Single-use, Sterile, 6/cs .....	16052
Surgical Trocar Sleeve, 10/11mm Single-use, Sterile, 6/cs .....	16162
Surgical Trocar Sleeve, 10/12mm Single-use, Sterile, 6/cs .....	16022
Blunt Tip (Hasson Style) Surgical Trocar, 10/11 mm Single-use, Sterile, 6/cs .....	16150
Surgical Trocar with Universal Converter, 5-11mm Single-use, Sterile, 6/cs .....	16911
Surgical Trocar with Universal Converter, 5-12mm Single-use, Sterile, 6/cs .....	16912
Universal Converter, 5-12mm Single-use, Sterile, 6/cs .....	1700
Converter, 5mm Single-use, Sterile, 6/cs .....	1705





# INSTRUMENTS



VCare® Plus

## VCare® Plus Uterine Manipulators



### VCare® Plus

VCare® Plus helps surgeons deliver superior control of the anatomy, effective uterine manipulation and identification of key surgical landmarks for a safe, efficient and repeatable procedure.

VCare® Plus, Small (32mm)  
Cervical Cup, 8/cs.....60-6085-200A

VCare® Plus, Medium (34mm)  
Cervical Cup, 8/cs.....60-6085-201A

VCare® Plus, Large (37mm)  
Cervical Cup, 8/cs.....60-6085-202A

VCare® Plus, X-Large (40mm)  
Cervical Cup, 8/cs.....60-6085-203A

### VCare® DX Plus

Provides excellent control of the uterus without distention of vaginal fornices. Ideal for:

- Tubal Ligation
- Myomectomies
- Diagnostic Laparoscopy
- Treatment of Endometriosis

VCare® DX Plus Manipulator, 8/cs.....60-6080-000A

### Anchor Tissue Retrieval System™

- Intuitive design enables ease of use
- Opens automatically when deployed
- Rip-stop nylon for exceptional strength and quality

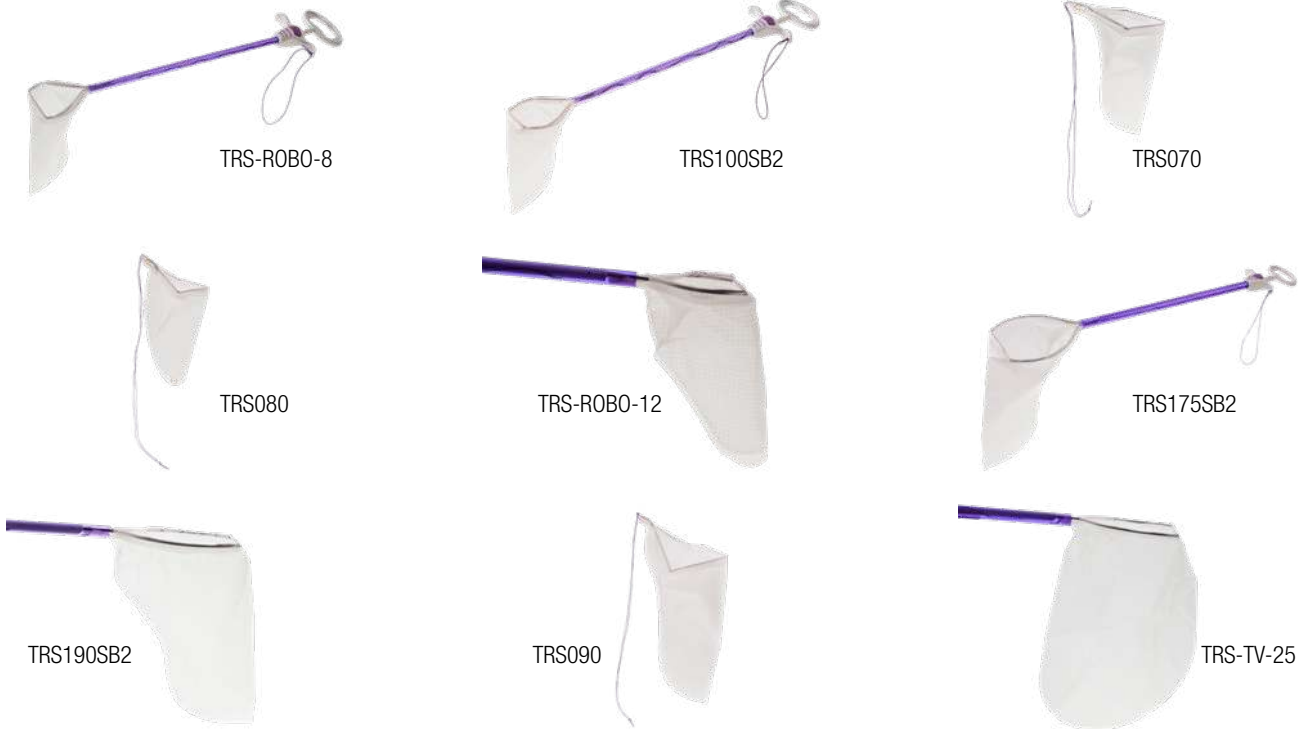

Introducer/Trocar Size	Mouth Diameter	Bag Length	Volume	Qty	Catalog Number
8mm	2.0in (5.1cm)	5.5in (14.0cm)	125ml	5/box	TRS-ROBO-8
10mm	2.2in (5.6cm)	5.5in (14.0cm)	235ml	5/box	TRS100SB2
10mm	2.2in (5.6cm)	5.5in (14.0cm)	235ml	10/box	TRS070
10/12mm	3.0in (7.6cm)	5.5in (14.0cm)	300ml	10/box	TRS080
12mm	3.0in (7.6cm)	5.5in (14.0cm)	300ml	5/box	TRS-ROBO-12
15mm	5.5in (14.1cm)	9.9in (25.4cm)	1550ml	3/box	TRS-VATS-15
15mm	5.5in (14.1cm)	9.9in (25.4cm)	1550ml	3/box	TRS175SB2
15mm	6.0in (15.2cm)	10.4in (26.5cm)	1850ml	3/box	TRS190SB2
15mm	5.5in (14.1cm)	9.9in (25.4cm)	1550ml	5/box	TRS090
25mm	6.5in (16.5cm)	15.0in (38.1cm)	4000ml	3/box	TRS-TV-25

# Disposable Laparoscopic Specimen Bags

## Disposable Laparoscopic Specimen Bags

Sterile, disposable device designed for use as a receptacle for the collection and extraction of tissue, and organs during laparoscopic surgical procedures. Consists of a flexible memory wire specimen bag and introducer. Use through a 5, 10, or 12mm cannula.



Description	Cannula	Diameter	Bag Length	Volume	Qty	Catalog Number
Attached Memory Wire Bag, Polymer	5mm	3in (7.62cm)	4in (10.2cm)	120ml	10/case	SB534
Independent Memory Wire Bag, Polymer	10mm	3in (7.62cm)	6in (15.24cm)	255ml	10/case	SB836
Independent Memory Wire Bag, Polymer	10mm	5in (12.7cm)	7in (17.78cm)	680ml	10/case	SB857
Attached Memory Wire Bag, Polymer	10mm	3in (7.62cm)	6in (15.24cm)	255ml	5/case	SB936
Attached Memory Wire Bag, Polymer	10mm	5in (12.7cm)	7in (17.78cm)	680ml	5/case	SB957
Attached Memory Wire Bag, Polymer	12mm	7.5in (19.1cm)	9in (22.9cm)	1500ml	5/case	SB979
Attached Memory Wire Bag, Nylon	10mm	3in (7.62cm)	6in (15.24cm)	255ml	5/case	SB1036
Attached Memory Wire Bag, Nylon	10mm	5in (12.7cm)	7in (17.78cm)	680ml	5/case	SB1057
Attached Memory Wire Bag, Nylon	12mm	7.5in (19.1cm)	9in (22.9cm)	1500ml	5/case	SB1079

**MicroLap® Instruments**

Designed to improve patient outcomes with a less invasive approach, this complete line of instruments delivers the strength of 5mm instruments through ports 4x smaller than standard trocars<sup>1,2</sup>.

**MicroLap® Curved Scissors**

Jaw Insert .....	C-LIL-IP-2SC-31ST
Insulated Outer Tube .....	C-LIL-TU-31
Red Handle.....	C-LIL-H-RP1



**MicroLap® Maryland Dissector**

Jaw Insert .....	C-LIL-IP-2DM-31
Insulated Outer Tube .....	C-LIL-TU-31
Blue Handle.....	C-LIL-H-BP1

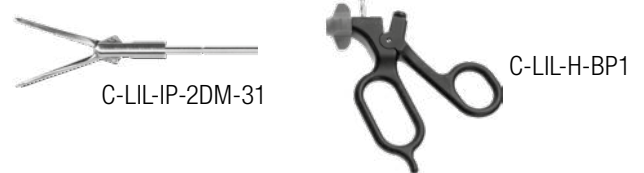

**MicroLap® Tapered Forceps**

Jaw Insert .....	C-LIL-IP-ST-31
Insulated Outer Tube .....	C-LIL-TU-31
Blue Handle.....	C-LIL-H-BP1

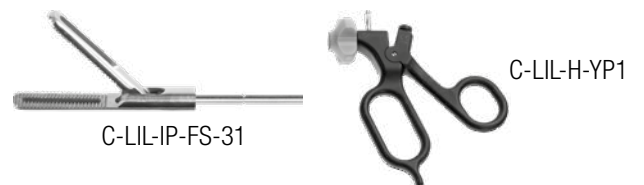

**MicroLap® Fenestrated Grasping Forceps**

Jaw Insert .....	C-LIL-IP-FS-31
Insulated Outer Tube .....	C-LIL-TU-31
Yellow Handle .....	C-LIL-H-YP1
Yellow Handle with Ratchet.....	C-LIL-H-YP2

**MicroLap® Clutch Grasping Forceps**

Jaw Insert .....	C-LIL-IP-CL-31
Insulated Outer Tube .....	C-LIL-TU-31
Yellow Handle .....	C-LIL-H-YP1
Yellow Handle with Ratchet.....	C-LIL-H-YP2

**MicroLap® Allis Grasping Forceps**

Jaw Insert .....	C-LIL-IP-AL-31
Insulated Outer Tube .....	C-LIL-TU-31
Yellow Handle .....	C-LIL-H-YP1
Yellow Handle with Ratchet.....	C-LIL-H-YP2



<sup>1</sup>Data on File, SurgiQuest 2015 REF 0408150930\_01.  
Wound area comparison between standard market leading 5mm trocar and Low Impact Trocar.  
<sup>2</sup>Data on File, SurgiQuest 2015 REF 0316151400\_00. Bend moment comparison test.

## MicroLap® Laparoscopic Instruments

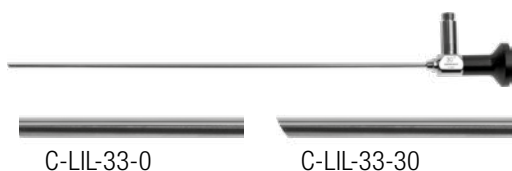

### MicroLap® Specialty Instruments

Aspiration Cannula, 330mm .....	C-LIL-PC-33
Aspiration Needle, 330mm .....	C-LIL-PN-33
Rounded Stylus, 330mm .....	C-LIL-RS-33

### MicroLap® Laparoscopes

0° Degree .....	C-LIL-33-0
30° Degree .....	C-LIL-33-30

### MicroLap® Trocars Cannula

60mm .....	C-LIL-C-060
75mm .....	C-LIL-C-075
100mm .....	C-LIL-C-100
120mm .....	C-LIL-C-120

### Helical Obturator

60mm .....	C-LIL-O-060H
75mm .....	C-LIL-O-075H
100mm .....	C-LIL-O-100H
120mm .....	C-LIL-O-120H

### Seal

Single Use, sterile pack, 25/box .....	C-LIL-SEAL-1
--	--------------

### MicroLap® Trocars (with Stop Cock)

Cannula, 3.5mm x 100mm .....	C-COEC35100RO
Helical Obturator, 3.5mm x 100mm .....	C-COEP35100H



## MicroLap® Cautery

### Bipolar Cautery

Bipolar Forceps Insert.....	C-LIL-IB-FS-35
Bipolar Over Tube.....	C-LIL-BTU-35
Bipolar Forceps Handle.....	C-LIL-H-BP
Bipolar Cable.....	85530101

### Monopolar Cautery

Monopolar "L" Hook, 330mm.....	C-LIL-LH-33
Monopolar "J" Hook, 330mm.....	C-LIL-JH-33
Monopolar Coagulation Tip, 330mm.....	C-LIL-CT-33
Monopolar Cable.....	60-5169-001

### Laparoscopic Suturing Instruments

Straight Needle Driver .....	C-LIL-NS-31
Knot Pusher, 330mm .....	C-LIL-KG-33

### Sterilization System for MicroLap® Instruments

Sterilization Container and Tray .....	SQ001
--	-------

### Sterilization System for MicroLap® Laparoscopes

Sterilization Container and Tray .....	SQ002
--	-------

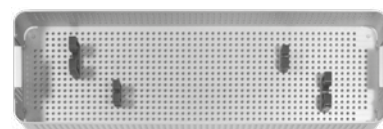
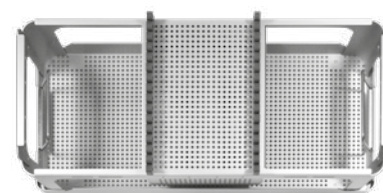

## DetachaTip® Laparoscopic Instruments



Curved Metzenbaum Scissor  
Curved Mini-Metzenbaum Scissor



Straight Fenestrated Grasper  
Endoweave Grasper  
Allis Grasper  
BABC®ock Grasper



Maryland (Curved) Dissector  
Meeker (Right Angle) Dissector  
Tapered (Dolphin) Dissector

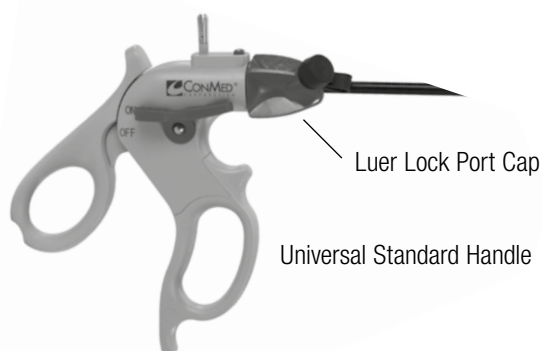

Luer Lock Port Cap  
Universal Standard Handle



3-4329

### DetachaTip® III Laparoscopic Instruments

Complimentary balance in a reusable handheld instrument system. Combines precise, reliable, and comfortable performance with dramatically reduced procedural costs. Only DetachaTip® III offers the optimal blend of performance and cost efficiency.

#### DetachaTip® III Scissors

Curved Metzenbaum, 5mm x 33cm .....	3-1003
Curved Metzenbaum, 5mm x 43cm .....	3-4301
Curved Mini-Metzenbaum, 5mm x 33cm .....	3-1004
Curved Mini-Metzenbaum, 5mm x 43cm .....	3-4304

#### DetachaTip® III Graspers

Straight Fenestrated Grasper, 5mm x 33cm .....	3-1008
Straight Fenestrated Grasper, 5mm x 43cm .....	3-4307
Endoweave Grasper, 5mm x 33cm .....	3-1028
Endoweave Grasper, 5mm x 43cm .....	3-4328
Allis Grasper, 5mm x 33cm .....	3-1019
Allis Grasper, 5mm x 43cm .....	3-4319
BABC®ock Grasper, 5mm x 33cm .....	3-1005
BABC®ock Grasper, 5mm x 43cm .....	3-4305
Long Fenestrated Grasper, 5mm x 33cm .....	3-1006
Long Fenestrated Grasper, 5mm x 43cm .....	3-4306
Claw Grasper, 5mm x 33cm .....	3-1011
Claw Grasper, 5mm x 43cm .....	3-4311

#### DetachaTip® III Dissectors

Maryland (Curved) Dissector, 5mm x 33cm .....	3-1009
Maryland (Curved) Dissector, 5mm x 43cm .....	3-4308
Meeker (Right Angle) Dissector, 5mm x 33cm .....	3-1017
Meeker (Right Angle) Dissector, 5mm x 43cm .....	3-4317
Tapered (Dolphin) Dissector, 5mm x 33cm .....	3-1018
Tapered (Dolphin) Dissector, 5mm x 43cm .....	3-4318
Blunt Nose Dissector, 5mm x 33cm .....	3-1012
Blunt Nose Dissector, 5mm x 43cm .....	3-4312

#### DetachaTip® III Handle

Universal Standard Handle with Ratchet .....	3-1010
--	--------

#### DetachaTip® III Sterilization Trays

DetachaTip® III Tray for 33cm / 43cm Instruments .....	3-4329
DetachaTip® III PLUS Tray for 33cm / 43cm Instruments .....	3-4343
DetachaTip® III Accessory	
Luer Lock Cap .....	CD203

### DetachaTip® II Scissors

Curved Metzenbaum, 5mm x 33cm .....	2-1003
Curved Metzenbaum, 5mm x 43cm .....	2-4301
Curved Mini-Metzenbaum, 5mm x 33cm .....	2-1004
Curved Mini-Metzenbaum, 5mm x 43cm .....	2-4304

### DetachaTip® II Graspers

Straight Fenestrated Grasper, 5mm x 33cm .....	2-1008
Straight Fenestrated Grasper, 5mm x 43cm .....	2-4307
Allis Grasper, 5mm x 33cm .....	2-1019
Allis Grasper, 5mm x 43cm .....	2-4319
Endoweave Grasper, 5mm x 33cm .....	2-1028
Endoweave Grasper, 5mm x 43cm .....	2-4328
BABC®ock Grasper, 5mm x 33cm .....	2-1005
BABC®ock Grasper, 5mm x 43cm .....	2-4305
BABC®ock Grasper, 10mm x 33cm .....	2-1014



Straight Fenestrated Grasper



Endoweave Grasper



Allis Grasper



BABC®ock Grasper (10mm)  
BABC®ock Grasper (5mm)

## DetachaTip® Laparoscopic Instruments



Maryland (Curved) Dissector



Tapered (Dolphin) Dissector



Meeker (Right Angle) Dissector



Universal Standard Handle with Ratchet



Luer Lock Cap



1-1027

### DetachaTip® II Dissectors

Maryland (Curved) Dissector, 5mm x 33cm.....	2-1009
Maryland (Curved) Dissector, 5mm x 43cm.....	2-4308
Meeker (Right Angle) Dissector, 5mm x 33cm.....	2-1017
Meeker (Right Angle) Dissector, 5mm x 43cm.....	2-4317
Tapered (Dolphin) Dissector, 5mm x 33cm.....	2-1018
Tapered (Dolphin) Dissector, 5mm x 43cm.....	2-4318

### DetachaTip® II Handles

Universal Standard Handle with Ratchet, Non Sterile.....	1-1010
Luer Lock Cap .....	CD203

### DetachaTip® II Sterilization Trays

DetachaTip® II Tray for 33cm Instruments.....	1-1027
Non-sterile, 1 each, for 33cm DetachaTip® instruments	

### Disposable Laparoscopic Scissors

- Wide opening scissors for improved dissection
- Extended insulation for maximum protection
- All instruments are packaged sterile
- Monopolar
- Disposable electro-surgical cord included
- Red rotation knob to indicate Scissor family
- 5 year shelf life

Curved Metzenbaum .....	60-6035-001
5mm x 32cm, 1/pkg, 5/cs	
Curved Metzenbaum, Narrow Tip .....	60-6035-001W
5mm x 32cm, 1/pkg, 5/cs	
Curved Metzenbaum .....	60-6035-431
5mm x 43cm, 1/pkg, 5/cs	
Curved Mini-Metzenbaum .....	60-6035-003
5mm x 32cm, 1/pkg, 5/cs	
Curved Mini-Metzenbaum .....	60-6035-433
5mm x 43cm, 1/pkg, 5/cs	
Straight .....	60-6035-002
5mm x 32cm, 1/pkg, 5/cs	
Mini Straight .....	60-6035-005
5mm x 32cm, 1/pkg, 5/cs	
Hook Blade .....	60-6035-004
5mm x 32cm, 1/pkg, 5/cs	

### Reflex® Disposable Laparoscopic Scissors

Reflex® Short Curved Scissors .....	1411
5mm x 32cm, (cord not included), 1/pkg, 6/cs	
Reflex® Long Curved Scissors .....	1412
5mm x 32cm, (cord not included), 1/pkg, 6/cs	

### Disposable Laparoscopic Scissors

Short Curved Mini Metzenbaum .....	1221
5mm x 33cm, (cord not included), 1/pkg, 10/cs	
Long Curved Metzenbaum .....	1222
5mm x 33cm, (cord not included), 1/pkg, 10/cs	



Curved Metzenbaum



Curved Metzenbaum  
Narrow Tip



Curved Mini-Metzenbaum



Straight



Mini Straight



Hook Blade



1411



1412



1221



1222

# Core™ Suction / Irrigation System

## Core™ Suction / Irrigation System

The Core™ Fluid Management System offers the benefit of a simple, easy to use suction and irrigation system with the convenience of a reusable suction cannula for added savings.

1. Select a Trumpet
2. Select a Suction Probe
3. Select an optional Electrode

### Trumpet Styles (Disposable)

Single bag, 10/box .....	CD8300
Single bag, 5mm, 32cm probe, 10/box .....	CD8185
Dual bag, 10/box .....	CD8302
Dual bag, 5mm, 32cm probe, 10/box .....	CD8190
Handpiece only, 20/box .....	CD8450
Handpiece with 5mm, 32cm probe, 20/box .....	CD8400



CD8300



CD8185



CD8302



CD8190



CD8450



CD8400

**Core™ Suction / Irrigation**

**Suction Probes (Reusable)**

10mm x 32cm with Holes.....	CD856
10mm x 32cm Poole.....	CD861
10mm x 20cm Stone Extractor with Sheath.....	CD862
5mm x 32cm Micro Tip.....	CD846
5mm x 32cm with Holes.....	CD860
5mm x 32cm Poole Suction.....	CD859
5mm x 45cm with Holes.....	CD849
3mm x 32cm with Holes (MicroLap).....	CD845

**Optional Electrodes (Reusable with integrated suction probe)**

5mm x 32cm Spatula.....	CD871
5mm x 32cm L-Hook.....	CD872
5mm x 32cm J-Hook.....	CD873
5mm x 32cm Needle.....	CD878
5mm x 32cm Electrode Probe Sheath.....	CD874

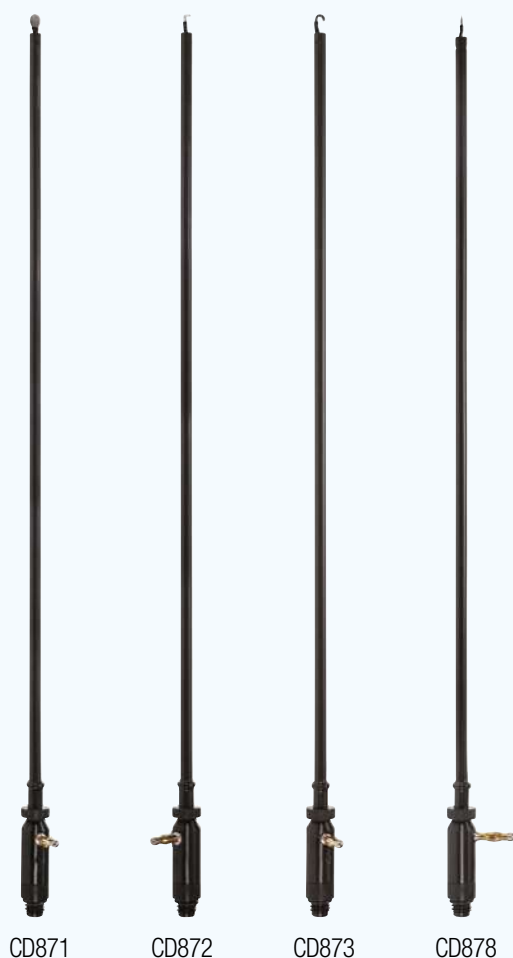

## Universal Plus® Suction / Irrigation



Pistol Grip



Straight Handle



Spatula



L-Hook

### Universal Plus® System

Electrosurgical and high volume suction/irrigation systems for laparoscopic surgery.

- Cut
- High Volume Suction
- Cauterize
- High Volume Irrigation
- Dissect
- Specimen Retrieval
- Laser
- Smoke Evacuation

### Pistol Grip

Pistol Grip, Foot Control E/S, Hand Control S/I, w/10' HiFlo tubing, irrig. bag spike and universal cord, 10/cs..... 60-6010-000

Pistol Grip, Hand Control E/S and S/I, w/10' HiFlo tubing, irrig. bag spike, 10/cs ..... 60-6010-002

Pistol Grip, Foot Control E/S, Hand Control S/I, w/10' HiFlo tubing, "Y" Connector for mechanical pumps and universal cord, 10/cs ..... 60-6010-020

Pistol Grip, Hand Control E/S and S/I, w/10' HiFlo tubing Irrigation "Y" Connector for mechanical pumps, 10/cs... 60-6010-022

### Straight Handle

Straight Handle, Foot Control E/S and S/I, w/10' HiFlo tubing, irrig. bag spike and universal cord, 10/cs ..... 60-6010-001

Straight Handle, Hand Control E/S (Buttons) and S/I, w/10' HiFlo tubing and irrig. bag spike, 10/cs..... 60-6010-003

Straight Handle, Hand Control E/S (Rocker switch) and S/I, w/10' HiFlo tubing and irrig. bag spike, 10/cs... 60-6010-005

### 5mm Electrosurgery Electrodes with Suction/Irrigation Optional Stealth ER Eschar Resistant Coating

Spatula  
27cm ..... 60-5272-027

32cm ..... 60-5272-032

Spatula with non-stick coating  
27cm ..... 60-5274-027

32cm ..... 60-5274-032

44cm ..... 60-5274-044

L-Hook  
27cm ..... 60-5272-127

32cm ..... 60-5272-132

L-Hook with non-stick coating  
27cm ..... 60-5274-127

32cm ..... 60-5274-132

44cm ..... 60-5274-144



## 5mm Electrosurgery Electrodes with Suction/Irrigation Optional Stealth ER Eschar Resistant Coating

J-Hook	
27cm .....	60-5272-227
32cm .....	60-5272-232
J-Hook with non-stick coating	
27cm .....	60-5274-227
32cm .....	60-5274-232
44cm .....	60-5274-244
Needle	
27cm .....	60-5272-927
32cm .....	60-5272-932
Needle with non-stick coating	
32cm .....	60-5274-932
44cm .....	60-5274-944

## Interchangeable Reusable Stainless Steel Suction/Irrigation Cannulas

10/10mm Sump Cannula	
with side holes, 32cm .....	60-6002-301
no side holes, 15cm .....	60-6002-305
5/5mm Sump Cannula	
with side holes, 32cm .....	60-6002-302
10mm cannula	
with side holes , 44 cm .....	60-6002-308
5mm cannula	
with side holes , 44 cm .....	60-6002-309

## Interchangeable Disposable Suction/Irrigation Cannulas

10/10mm Sump Cannula	
with side holes 32cm .....	60-6001-110
10/10mm "Soft-Tip" Sump Cannula	
with side holes, 32cm .....	60-6000-130
10/5mm Sump Cannula	
with side holes, 32cm .....	60-6001-108
5/5mm Sump Cannula	
with side holes 32cm .....	60-6001-203
with side holes, 44cm .....	60-6001-205
5/5mm Laser Access Cannula	
with side holes 32cm .....	60-6001-360
with side holes, 44cm .....	60-6001-361

## FloVac 10K pump

FloVac offers outstanding value as a system designed especially for suction and irrigation when electrosurgery is not required. Choose from two styles of control handles - one that accepts our wide range of removable cannula or one with a pre-attached 5mm sump cannula.

For use with Universal Plus, Universal S/I, PowerFlo, and FloVac Control Handles.

FloVac with Universal Connector .....	60-6005-500
FloVac with 5mm x 32cm Cannula .....	60-6005-505



J-Hook



J-Hook with non-stick coating



Needle



Needle with non-stick coating



Sump Cannula



10/10 Sump Cannula



10/10 Soft-Tip Sump Cannula



5/5 Sump Cannula



Laser Access Cannula



60-6005-505

## Reflex® Series Ligation / Skin Staplers

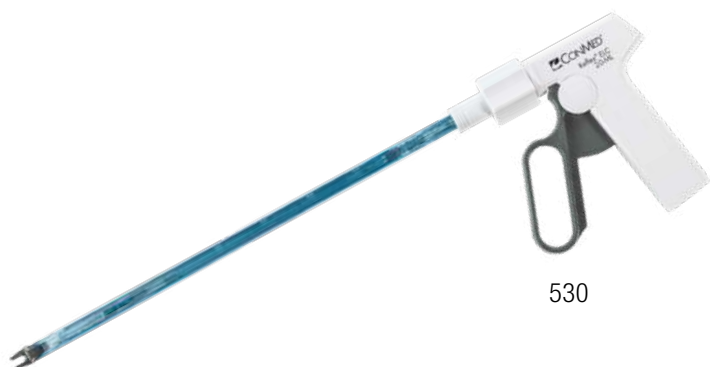

530



3036



3036R



3031

### Reflex® ELC530 Disposable Laparoscopic Clip Applier

#### Maximum Visibility

By comparison, the Reflex® ELC jaw design has a 20% greater angle allowing for maximum visibility for precise clip placement.

#### Maximum Control

The Reflex® ELC has an automatic, direct drive clip feeding system with an audible feedback mechanism indicating complete clip closure. Our superior design provides maximum control, feel and ease-of-use.

#### Tissue Lock Clip

The Tissue Lock Clip is designed with opposing male/female interlocking features. This design provides superior on-vessel clip retention and improved hemostasis.

10mm, 20 M/L Clips, 6/cs..... 530

### Reflex® One Skin Staplers

- Flexibility of movement
- Fully retracting anvil permits staple release while moving forward or backward unlike competitive models which require you to “back off” before moving forward
- Reflex® One releases staple when the handle is fully depressed.
- Complete staple formation is confirmed by audible and tactile feedback.

35 Wide, 6/box ..... 3036

35 Wide, 50/box ..... 853590

35 Regular, 6/box ..... 3036R

### Reflex® TL Tissue Lift Skin Stapler

- Additional control
- Reflex® TL incorporates a semi-retracting anvil that only releases a staple when the handle is fully released
- Semi-retracting anvil gives the TL its “Tissue Lift” which assists in approximating the incision for easier placement of the next staple

35 Wide, 6/box ..... 3013

35 Wide, 50/box ..... 873590

35 Regular, 6/box ..... 3013R

### Reflex® Extractor

- Ergonomically designed to help reduce patient discomfort

Skin Staple Extractor 12/box..... 3031

### Reflex® RHS Re-Loadable Rotating Head Skin Stapler

One (1) each single-use handle and cartridge

- Re-loadable within single patient use

Wide, Sterile, 1/pkg, 6/cs ..... 8935

**Kittner Blunt Dissectors**

Convenient, cost-effective packaging houses sponge and blunt tip probes. Non-absorbant radiopaque tip.

- Single tip Kittner, 5mm x 40cm, single use, sterile  
5/case ..... CD801
- Dual tip Kittner, 5mm x 40cm, single-use, sterile  
5/case..... CD802

**Anti-Fog Kit**

Water-based solution reduces fogging of scopes. Includes adhesive backed sponge with radiopaque ribbon.

- 6cc anti-fog solution single-use, sterile  
10/case..... CD004



CD801



CD004

ENERGY



HelixAR™ System



VisiClear® VC220

VS1354



EZLink®  
(sold separately; catalog #: EZLINK01)



Pneumatic Footswitch  
(included)



ViroSafe® Fluid Trap  
(sold separately; catalog #: VSFT10)



VC220P1

## VisiClear® - Surgical Smoke Evacuator

VisiClear® is our most advanced acute care offering for surgical smoke evacuation. Combining Safeport Technology, an occlusion warning, filter life tracking, and one-touch programmable procedure modes for open tubing, electrosurgical pencil, and laparoscopic procedures, VisiClear® effectively captures and filters surgical smoke, particulates and other potentially hazardous by-products. The filter contains activated carbon known to adsorb gases.

220/240 Volt Systems..... VC220

(includes one footswitch and filter)

220/240 Volt Systems..... VC220NF

(includes one footswitch)

VisiClear® 220V System with 3-Port filter (incl pneumatic footswitch and 1 3-port filter), sealed with exhaust..... VC220P1

ViroSafe® VisiClear® Filter..... VS135 Series

(1/case).....VS135

(2/case).....VS1352

(4/case).....VS1354

## EZLink®

Activation Device used to remotely turn all current Buffalo Filter® surgical smoke evacuators on and off in conjunction with Electrosurgical Unit activation saving filter life.

Adjustable delay allows for capture of residual smoke that may be present after deactivation of electrosurgery devices.

Multiple cautery pencils can be accommodated with one EZLink® device providing savings and convenience to facility.

Easy set-up; requires no programming.

(1/case).....EZLINK01

## ViroVac® - Surgical Smoke Evacuator

ViroVac® surgical smoke evacuator provides ideal flow for physician offices and outpatient surgery centers. It combines customizable (variable) filter life, a compact shelf design, 3-port filter with filter life tracking technology, while exceeding expectations for value and efficacy.

220/240 Volt Systems.....VV220

(includes one filter and one footswitch)

ViroVac® 220V smoke evacuation system (incl pneumatic footswitch and 1 filter), sealed with exhaust..... DKW220

220/240 Volt Systems.....VV220NF

(includes one filter and one footswitch)

ViroSafe® ViroVac® Filter ..... VS353 Series  
Filter Life ..... 18, 24, 35 hours (depending on flow rate)

220/240 Volt exhaust sealed system ..... DKW220

## ViroSafe® ViroVac® Filter

Designed to fit ViroVac

4 layers of proven filtration gross particulate, ULPA media, activated carbon, and post filter.

Last up to 35 hours of smoke evacuation time and captures 0.1 to 0.2 micron particles at 99.999% efficiency.

Hidden ports reduce the risk to caregivers of cross contamination.

3-port filter — 1/4 in (6.4 mm), 3/8 in (9.5 mm) and 7/8 in (22 mm)  
(1/case).....VS353  
(2/case).....VS35302  
(4/case).....VS35304

## ClearView™ Smoke Evacuation System

CONMED's ClearView™ Smoke Evacuation System is a compact, quiet and effective smoke evacuation solution with state-of-the-art ULPA filtration to combat airborne hazards by removing 99.999% of the smoke contaminants<sup>1</sup>.

## ClearView™ Smoke Evacuator

ClearView™ Smoke Evacuator – 220/240V,  
Includes: AC Power Cord, Automatic Activation Device,  
Pneumatic Footswitch, Operator's Manual,  
and one filter .....60-8585-230

## ClearView™ Accessories

ClearView™ Replacement Filter, 2/case .....60-8590-001  
ClearView™ Automatic Activation Device .....60-8597-001  
CONMED Fluid Trap, For use with ClearView™ Unit,  
10/pkg .....60-8596-001



ViroVac®



DKW220



Pneumatic Footswitch  
(included)



VS353



ClearView

<sup>1</sup>Author; Environmental Protection Agency EPA-CICA Fact Sheet, EPA-425/F-03-023. Title: Air Pollution Control Technology Fact Sheet [2013].

## Surgical Smoke Evacuators



PlumeSafe® Turbo



Pneumatic Footswitch  
(included)

### PlumeSafe® Turbo - Surgical Smoke Evacuator

PlumeSafe® Turbo is a powerful portable surgical smoke evacuator designed with sufficient flow for the aesthetic market. It features turbo suction power, an interactive LCD display and filter tracking technology. It can easily be placed on a counter, shelf, floor or other location convenient to the operative area.

220/240 Volt 50/60 Hz .....PSWTURBO\_AS/220  
(includes one footswitch; filter sold separately)

PlumeSafe® Turbo  
Replacement Filters ....VS06, VSXLL, VSXLLT, VSEY, VSOH, and VSVET  
Series



## Surgical Smoke Evacuation Pencils & Pencil Adapters

### PlumePen® Ultra - Surgical Smoke Evacuation Pencils

PlumePen® Ultra (Non-Stick ESU Blade) 20/case .....PLPUL2020  
 (Includes 3/8 in (9.5 mm) x 10 ft (3 m) hose/tubing  
 & 7/8 in (22 mm) filter port adapter.)

PlumePen® Ultra (Non-Stick ESU Blade) 20/case .....PLPUL2520  
 (Includes 3/8 in (9.5 mm) x 15 ft (4.6 m) hose/tubing  
 & 7/8 in (22 mm) filter port adapter.)

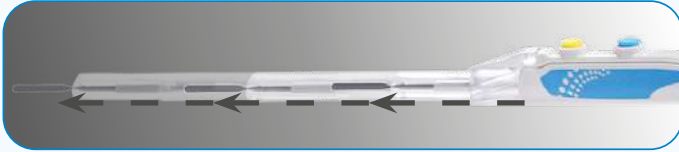

**Telescopic Capture Port**  
 Extends up to 5.3 in (135 mm)

### PlumePen® Elite - Surgical Smoke Evacuation Pencils

PlumePen® Elite (Non-Stick ESU Blade)  
 20/case.....PLP2020  
 (Includes 3/8 in (9.5 mm) x 10 ft (3 m) tubing with adapter  
 to 7/8 in (22 mm) port.)

PlumePen® Elite (Non-Stick ESU Blade)  
 20/case.....PLP2520  
 (Includes 3/8 in (9.5 mm) x 15 ft (4.6 m) tubing with adapter  
 to 7/8 in (22 mm) port.)



**Multi-Directional Swivel**  
 Provides for superior hand  
 movement and less wrist drag  
 than competitive products

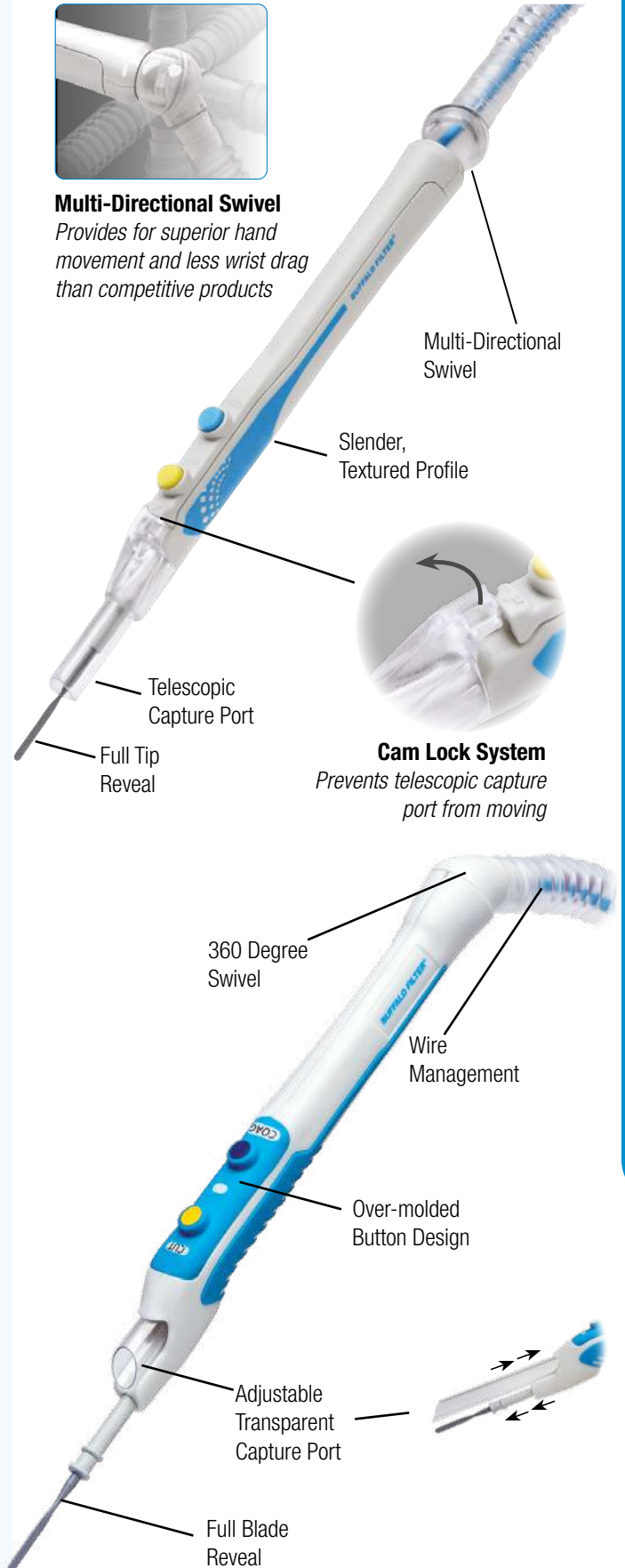

Multi-Directional Swivel

Slender, Textured Profile

Telescopic Capture Port

Full Tip Reveal

**Cam Lock System**  
 Prevents telescopic capture port from moving

360 Degree Swivel

Wire Management

Over-molded Button Design

Adjustable Transparent Capture Port

Full Blade Reveal

## Surgical Smoke Evacuation Pencils & Pencil Adapters



Additional capture ports available to accommodate 4 in (102 mm) and 6 in (152 mm) electrodes.



### PlumePen® Pro Surgical Smoke Evacuation Pencils

PlumePen® Pro (Non-Stick ESU Blade)  
20/case..... PLPR04020  
(Includes 3/8 in (9.5 mm) x 10 ft (3 m) tubing with adapter to 7/8 in (22 mm) port.)

PlumePen® Elite (Non-Stick ESU Blade)  
20/case..... PLPR04520  
(Includes 3/8 in (9.5 mm) x 15 ft (4.6 m) tubing with adapter to 7/8 in (22 mm) port.)

Capture Ports (X-ray detectable)  
20/case..... PROTIP420  
(Accommodates 4 in [102 mm] electrodes)

PlumePen® Pro Capture Ports - (x-ray detectable)  
20/case ..... PROTIP520  
(Accommodates 5 in (127 mm) electrodes.)

Capture Ports (X-ray detectable)  
20/case..... PROTIP620  
(Accommodates 6 in [152 mm] electrodes)

### SnapEvac™ Surgical Smoke Evacuation Pencils

SnapEvac  
20/case..... SnapEvac20  
(Designed using ABS plastic and a polycarbonate capture port. Includes 10 ft (3 m) tubing with a 7/8 in (22 mm) cuff.)

## Surgical Smoke Evacuation Pencils & Pencil Adapters

### GoldVac® Slim Smoke Evacuation Pencils

GoldVac® Slim Pencil, Push Button,  
2,5 cm UltraClean® Blade Electrode  
3 m of 9.5mm tubing, Disposable, 20/case .....60-7610-001

GoldVac® Slim Pencil, Push Button,  
2,5 cm UltraClean® Blade Electrode  
4,5 m of 9.5mm tubing, Disposable, 20/case .....60-7670-001

### GoldVac® Smoke Evacuation Pencils

GoldVac® Pencils allow the surgeon to position the 6" extendable smoke elimination tube anywhere along the active electrode for effective smoke capture, with accessibility and visibility of the surgical site. Swivels 360° to eliminate wrist drag, and enable maximum maneuverability.

### GoldVac® Smoke Evacuation Pencils

GoldVac® Pencil, Push Button, 2,5 cm UltraClean® Blade Electrode,  
3 m Tubing, Disposable, 10/case .....60-7510-005

GoldVac® Pencil, Rocker Switch, 2,5 cm UltraClean® Blade Electrode,  
3 m Tubing, Disposable, 10/case .....60-7520-005

GoldVac® Pencil, Foot Control, 2,5 cm UltraClean® Blade Electrode,  
3 m Tubing, Disposable, 10/case .....60-7530-005

GoldVac® Pencil, Push Button, 2,5 cm UltraClean® Blade Electrode,  
4,5 m Tubing, Disposable, 10/case .....60-7570-005

GoldVac® Pencil, Rocker Switch, 2,5 cm UltraClean® Blade Electrode,  
4,5 m Tubing, Disposable, 10/case .....60-7580-005

### GoldVac® UltraClean® Electrodes

10 cm GoldVac® UltraClean® Blade, 25/case .....60-7524-001

15 cm GoldVac® UltraClean® Blade, 25/case .....60-7526-001

2,5 cm GoldVac® UltraClean® Blade with Extended Insulation  
25/case .....60-7521-001

10 cm GoldVac® UltraClean® Blade with Extended Insulation  
25/case .....60-7522-001

15 cm GoldVac® UltraClean® Blade with Extended Insulation  
25/case ..... 60-7523-001



GoldVac® Slim



GoldVac

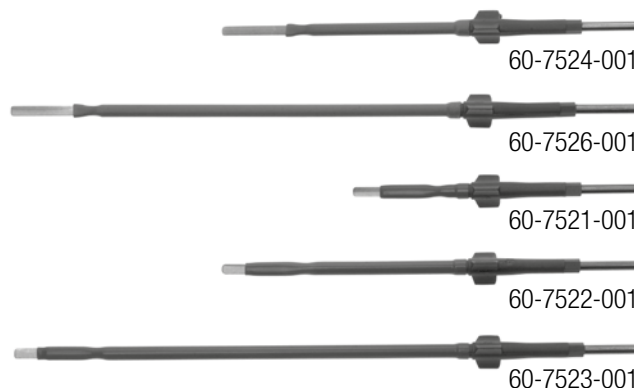

60-7524-001

60-7526-001

60-7521-001

60-7522-001

60-7523-001

## Surgical Smoke Evacuation Pencils & Pencil Adapters

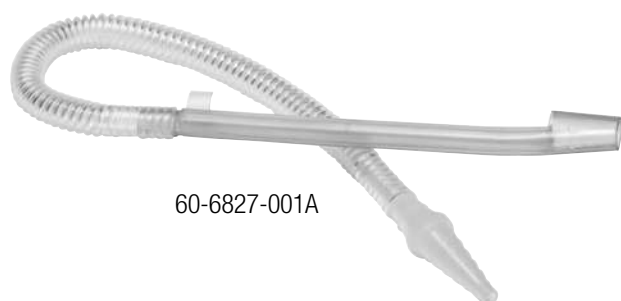

60-6827-001A



60-6828-005A



60-6805-001



60-6810-001



60-6815-001

### ClearVac Smoke Evacuation Pencils

ClearVac Electrosurgical Pencil Smoke Attachment with 12" of 10mm Tubing and 5-in-1 Adapter, Single Use, Sterile, 25/case .....60-6827-001A

ClearVac GoldLine® Push Button Electrosurgical Pencil Smoke Attachment with 4' of 10mm Tubing and 6' of 22mm Tubing, Standard Blade Electrode, Holster, Single Use, Sterile, 10/case .....60-6828-001A

ClearVac GoldLine® Rocker Switch Electrosurgical Pencil Smoke Attachment with 4' of 10mm Tubing and 6' of 22mm Tubing, Standard Blade Electrode, Holster, Single Use, Sterile, 10/case .....60-6829-001A

ClearVac GoldLine® Push Button Electrosurgical Pencil Smoke Attachment with 4' of 10mm Tubing and 6' of 22mm Tubing, UltraClean® Blade Electrode, Holster, Single Use, Sterile 10/case .....60-6828-005A

ClearVac GoldLine® Rocker Switch Electrosurgical Pencil Smoke Attachment with 4' of 10mm Tubing and 6' of 22mm Tubing, UltraClean® Blade Electrode, Holster, Single Use, Sterile, 10/case .....60-6829-005A

ClearVac Electrosurgical Smoke Evacuation Handpiece Attachment with 4' of 10mm Tubing and 6' of 22mm Tubing, Single Use, Sterile, 10/case .....60-6839-001A

ClearVac GoldLine® Foot Control Electrosurgical Pencil Smoke Attachment with 4' of 10mm Tubing and 6' of 22m Tubing, UltraClean® Blade Electrode, Holster, Single Use, Sterile, 10/case ..... 138663A

### Smoke Evacuation Tubing

Hand-held Smoke Evacuation Tubing, 6' (1.8m), 7/8" diameter Single use; Sterile, 5/case.....60-6805-001

Laparoscopic Smoke Evacuation Tubing Set, 10' (3.05m) 1/4" diameter with luer lock Single use; Sterile, 5/case ....60-6810-001

LEEP Tubing Set, 10' (3.05m), Non-sterile, 5/case .....60-6815-001

Tubing Set with .2 micron filter and adjustable valve for laser and cautery smoke in laparoscopy..... CD3900

## PenAdapt® - Surgical Smoke Evacuation Pencils

### PenAdapt

Ideal for wall suction applications.

25/case.....PA1025  
(Includes 3/8 in (9.5 mm) x 1 ft (30.5 cm) tubing with an adapter to 3/8 in (9.5 mm) tube.)

### PenAdapt® (Cut-back)

Ideal for wall suction applications. Cut-back adapter provides increased visibility.

25/case..... PA1025CB  
(Includes 3/8 in (9.5 mm) x 1 ft (30.5 cm) tubing with an adapter to 3/8 in (9.5 mm) tube.)

### PenAdapt

Ideal for surgical smoke evacuator applications.

10/case.....PA2010  
(Includes 3/8 in (9.5 mm) x 4 ft (1.22 m) tubing with an adapter to 7/8 in (22 mm) x 6 ft (1.8 m) tube.)

### PenAdapt® (Cut-back)

Ideal for surgical smoke evacuator applications. Cut-back adapter provides increased visibility.

10/case..... PA2010CB  
(Includes 3/8 in (9.5 mm) x 4 ft (1.22 m) tubing with an adapter to 7/8 in (22 mm) x 6 ft (1.8 m) tube.)

### PenAdapt

Ideal for attachment to reusable electro-surgical pencil applications.

10/case..... PA2010B  
(Includes 3/8 in (9.5 mm) x 4 ft (1.22 m) tubing with an adapter to 7/8 in (22 mm) x 6 ft (1.8 m) tube.)

### PenAdapt

Ideal for attachment to reusable electro-surgical pencil applications. Cut-back adapter provides increased visibility.

10/case..... PA2010BCB  
(Includes 3/8 in (9.5 mm) x 4 ft (1.22 m) tubing with an adapter to 7/8 in (22 mm) x 6 ft (1.8 m) tube.)



PenAdapt



PA1025, PA1025CB,  
PA2010, PA2010CB



PA2010B, PA2010BCB

## Surgical Smoke Evacuation Tubing & Accessories



ST10105



VT38S1010



VT10424



VT10610



VTEYKIT

### 1/4 in (6.4 mm) Smoke Evacuation Tubing

NON-STERILE

Excellent for use with filtered wall suction and for situations where space is limited.

1/4 in (6.4 mm) x 2 ft (.6 m) 5/case.....ST10105

### 3/8 in (9.5 mm) Smoke Evacuation Tubing

STERILE

Excellent for use in an office setting and in small pockets where space is limited.

3/8 in (9.5 mm) x 10 ft (3.0 m) 10/case.....VT38S1010

### 7/8 in (22 mm) Smoke Evacuation Tubing

The most common and versatile size of tubing, combining a compact size and increased airflow.

STERILE

7/8 in (22 mm) x 6 ft (1.8 m) 24/case.....VT10424

7/8 in (22 mm) x 10 ft (3.0 m) 24/case.....VT10624

NON-STERILE

7/8 in (22 mm) x 6 ft (1.8 m) with (12) 7/8 in tubing-to-tubing connectors (extension tubing) 24/case.....VT10324

7/8 in (22 mm) x 10 ft (3.0 m) 10/case.....VT10524-10

7/8 in (22 mm) x 10 ft (3.0 m) 24/case.....VT10524

7/8 in (22 mm) x 6 ft (1.8 m) 6/case.....VT78-6

7/8 in (22 mm) x 2.5 ft (.7 m) (Replaces suction canister connecting tube) 10/case.....VT10610

### 1-1/4 in (32 mm) Smoke Evacuation Tubing

A wide diameter tubing, ideal for cases producing large amounts of smoke and odors such as aesthetic procedures and Trans-urethral Resection of the Prostate (TURP) procedures.

STERILE

1-1/4 in (32 mm) x 6 ft (1.8 m) 6/case.....VT10206

NON-STERILE

1-1/4 in (32 mm) x 6 ft (1.8 m) 6/case.....VT10106

1-1/4 in (32 mm) x 10 ft (3.0 m) 6/case.....VT10306

1-1/4 in (32 mm) x 2 ft (.6 m) 10/case.....VT10510

### 1-3/8 in (35 mm) Erbium: Yag Tubing Kit

NON-STERILE

1-3/8 in (35 mm) x 6 ft (1.8 m) tube (replace as needed) and six 2 ft (.6 m) length tubes with integral wand & sponge guard to be replaced each procedure (1/kit).....VTEYKIT

## Speculum Tubing

### STERILE

Ideal for connection to surgical speculum, laryngoscope, or small area applications.

7/8 in (22 mm) x 6 ft (1.8 m) with 7/8 in (22 mm) to 1/4 in (6.4 mm) reducer to 1/4 in (6.4 mm) x 2 ft (.6 m) tubing (5/case).....VTESU05

### NON-STERILE

Ideal for connection to surgical speculum or small area applications.

7/8 in (22 mm) x 6 ft (1.8 m) with 7/8 in (22 mm) to 1/4 in (6.4 mm) reducer to 1/4 in (6.4 mm) x 2 ft (.6 m) tubing (5/case).....PSFTS05



VTESU05

## Pencil Adapter Tubing Set

### STERILE

7/8 in (22 mm) x 6 ft (1.8 m) with 7/8 in (22 mm) to 3/8 in (9.5 mm) reducer and 3/8 in (9.5 mm) x 4 ft (1.2 m) (10/case) .....VTVIC10



VTVIC10

## 7/8 in (22 mm) Tubing with Wand and Sponge Guard

### STERILE

7/8 in (22 mm) x 6 ft (1.8 m) tubing with 8 in (20 cm) integral wand and sponge guard (24/case) .....VTWT424

7/8 in (22 mm) x 10 ft (3.0 m) tubing with 8 in (20 cm) integral wand and sponge guard (24/case) .....VTWT624

7/8 in (22 mm) x 14 ft (4.3 m) tubing with 8 in (20 cm) integral wand and sponge guard (5/case) .....VTWT805

7/8 in (22 mm) x 10 ft (3.0 m) tubing with 8 in (20 cm) integral wand and sponge guard with 7/8 in to 1-3/8 in (35 mm) adapter (10/case).....VTWTS10

### NON-STERILE

7/8 in (22 mm) x 6 ft (1.8 m) tubing with 8 in (20 cm) integral wand and sponge guard (24/case) .....VTWT324

7/8 in (22 mm) x 10 ft (3.0 m) tubing with 8 in (20 cm) integral wand and sponge guard (24/case) .....VTWT524



VTWT424



VTWT206

## 1-1/4 in (32 mm) Tubing with Wand and Sponge Guard

### STERILE

1-1/4 in (32 mm) x 6 ft (1.8 m) tubing with 8 in (20 cm) integral wand and sponge guard (6/case) .....VTWT206

## 1-3/8 in (35 mm) Tubing with Wand and Sponge Guard

### STERILE

1-3/8 in (35 mm) x 6 ft (1.8 m) with wand and sponge guard (5/case).....VTWT505

1-3/8 in (35 mm) x 10 ft (3.0 m) with wand and sponge guard (5/case).....VTWT515



VTWT505

## Surgical Smoke Evacuation Tubing & Accessories



VT10405



RF10210



RF10112



RF12524



RF783824



RF10512



RF10705



RF10905

### 7/8 in (22 mm) Tubing with Adapters

STERILE

7/8 in (22 mm) to 3/8 in (9.5 mm) reducer fitting with  
7/8 in (22 mm) x 6 ft (1.8 m) tubing (5/case).....VT10405

STERILE

7/8 in (22 mm) to 1/4 in (6.4 mm) reducer fitting with  
2 ft (.6 m) x 1/4 in (6.4 mm) tubing (10/case).....RF10210

NON-STERILE

7/8 in (22 mm) to 1/4 in (6.4 mm) reducer fitting with  
2 ft (.6 m) x 1/4 in (6.4 mm) tubing (10/case).....RF10110

### Reducer Fittings/Adapters

NON-STERILE

7/8 in (22 mm) to 1/4 in (6.4 mm) reducer fitting  
(12/case).....RF10112

NON-STERILE

7/8 in (22 mm) to 1/4 in (6.4 mm) reducer fitting  
with 2 in (5.1 cm) cuff (24/case).....RF12524

NON-STERILE

7/8 in (22 mm) to 3/8 in (9.5 mm) reducer fitting  
with 2 in (5.1 cm) cuff (24/case).....RF783824

NON-STERILE

7/8 in (22 mm) to 3/8 in (9.5 mm) reducer fitting  
(12/case).....RF10512

NON-STERILE

1-3/8 in (35 mm) to 7/8 in (22 mm) reducer fitting  
(5/case).....RF10705

NON-STERILE

1-3/8 in (35 mm) to 3/8 in (9.5 mm) reducer fitting  
(10/case).....RF13810



**PlumePort® ActiV® - Laparoscopic Solutions**

PlumePort® ActiV® is the first line of defense designed for safe, effective removal of surgical smoke during laparoscopic procedures. ActiV easily attaches to standard trocars and utilizes readily available suction systems providing noiseless operation.

With a built-in fluid trap, moisture is effectively managed throughout the entire procedure to ensure uninhibited flow and prevent filter saturation without compromising the integrity of the filtration media.

ActiV provides up to 50% more flow capability than competitive passive laparoscopic filters while maintaining ULPA filtration and significantly outperforms competitive devices when exposed to high moisture environments. In addition to ULPA filtration, ActiV contains activated carbon known to adsorb gases.

PlumePort® ActiV® (10/case) ..... PP010CS

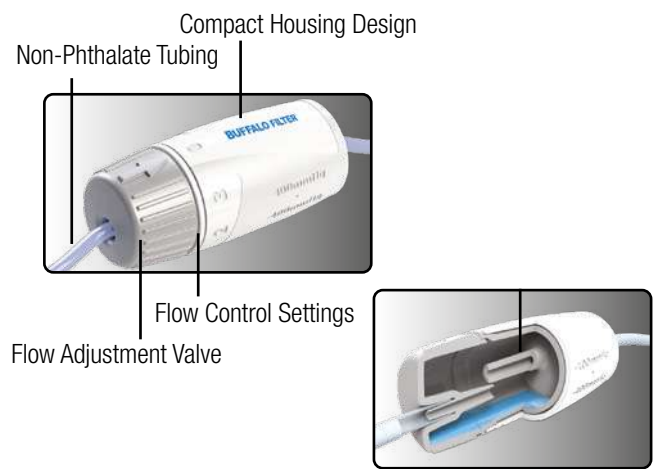

**PlumePort® - Laparoscopic Solutions**

PlumePort® is a passive laparoscopic smoke filtration device with integrated ULPA filtration coupled with activated carbon to safely filter the aerosolized contents of peritoneal smoke during laparoscopy. Containing more than two times the ULPA media as competitive passive devices, and a dual management moisture control process of a wicking agent and fluid trap, PlumePort® offers essential media integrity for greater protection during longer cases.

PlumePort® (10/case)..... PP010

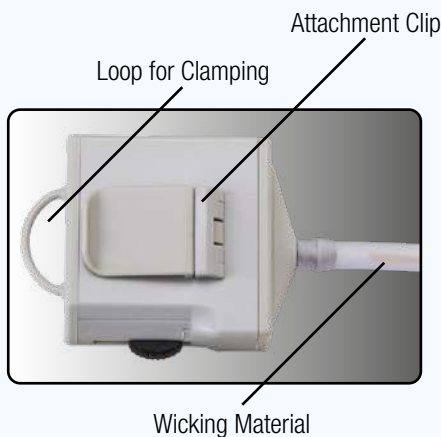
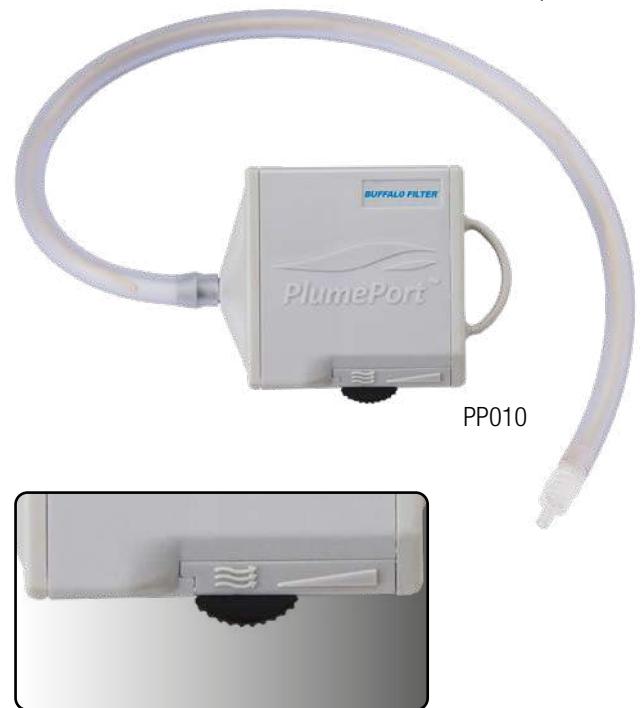

Adjustable Flow Control

## Laparoscopic Solutions

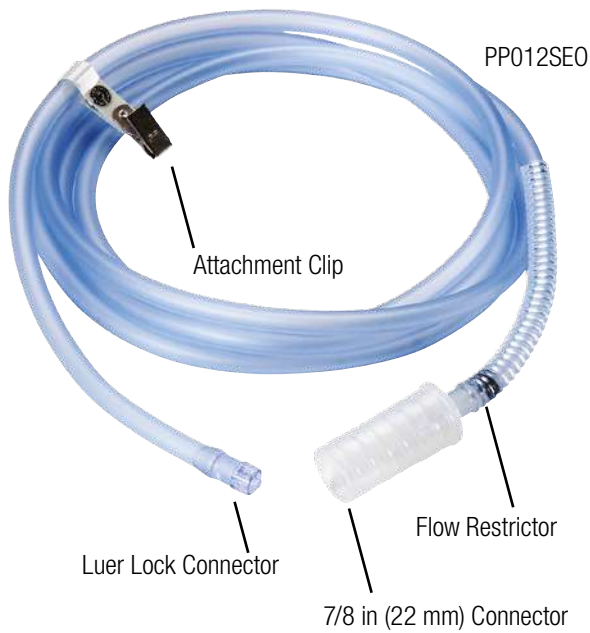

### PlumePort® SEO - Laparoscopic Solutions

PlumePort® SEO easily connects from a standard trocar to a smoke evacuator for efficient and safe removal of surgical smoke during laparoscopic procedures. Utilizing available surgical smoke evacuators and coupling it with this flow controlled device, PlumePort® SEO provides fast and safe smoke management while maintaining peritoneal distention.

PlumePort® SEO (12/case) ..... PP012SEO

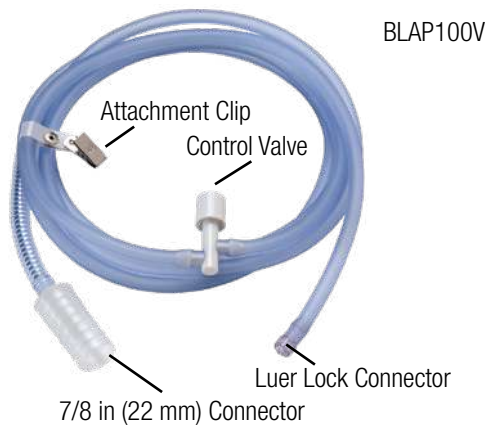

### PlumePort® SEV - Laparoscopic Solutions

PlumePort® SEV is a sterile laparoscopic smoke filtration device that connects from a standard surgical trocar to a smoke evacuator for efficient and safe removal of surgical smoke during laparoscopic procedures. The surgical smoke evacuation is controlled via the surgical smoke removal valve.

PlumePort® SEV (12/case).....BLAP100V

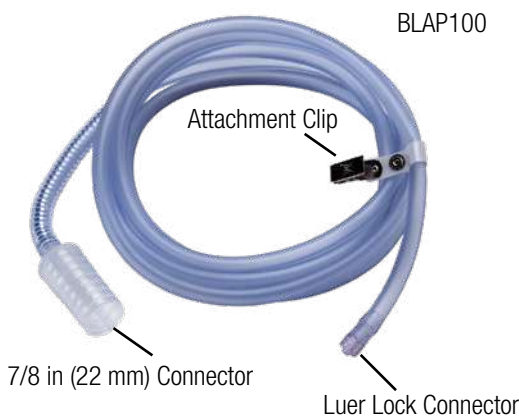

### PlumePort® SE - Laparoscopic Solutions

PlumePort® SE is sterile smoke management tubing that connects from a standard surgical trocar to a smoke evacuator for efficient and safe removal of surgical smoke during laparoscopic procedures.

PlumePort® SE (12/case).....BLAP100

**LaparoVue® Visibility System - Laparoscopic Solutions**

LaparoVue® is an all-in-one solution designed to take the complexity out of achieving optimal visualization. An easy to use, disposable multi-purpose device that warms, white balances, cleans and defogs, LaparoVue® eliminates the necessity for multiple product purchases.

LaparoVue® Visibility System (10/case).....LAPVUE10



warms & white balances



cleans

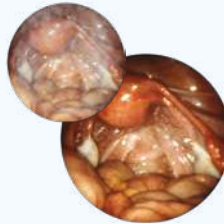

defogs\*

\* Photographs are representative of a fogged and clear/defogged lens but do not reflect actual product use.



LAPVUE10

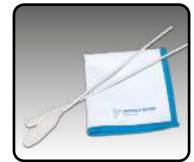

VueTip® Trocar Swab Accessory Kit  
(also sold separately; catalog # VueTip10)

## Accessories



VUETIP10

### VueTip® Trocar Swab Accessory Kit

Kit contains both a radiopaque Microfiber Cloth (non-abrasive) that can be used to clean the scope lens and two VueTip® Trocar Swabs for 3–7 mm and 7–12 mm trocar cannulas.

(10/case).....VueTip10



EZLINK01

### EZLink®

Activation Device used to remotely turn all current Buffalo Filter® surgical smoke evacuators on and off in conjunction with Electrosurgical Unit activation saving filter life.

Adjustable delay allows for capture of residual smoke that may be present after deactivation of electrosurgery devices.

Multiple cautery pencils can be accommodated with one EZLink® device providing savings and convenience to facility.

Easy set-up; requires no programming.

(1/case).....EZLINK01



FS10004

### Pneumatic Footswitch

Designed to work with all current Buffalo Filter® surgical smoke evacuators.

Features 10 ft length (3.0 m).

(1/case).....FS10004



VSFT10

### ViroSafe® Fluid Trap

Designed to capture fluids to help maintain the integrity of the filtration system and assist with maintaining filter life.

Translucent design with simple to read measurement increments (holds up to 100 cc fluid capacity).

Easy to attach and remove with cap holder for easy storage of caps during use.

7/8 in (22 mm) and 1/4 in (6.4 mm) tubing connection ports.

Fits 7/8 in (22 mm) port of Buffalo Filter® ViroSafe® Filters.

(10/case).....VSFT10



DCCM01

### Direct Connect Cables

Direct Connect Cable for ConMed Electrosurgical Units (certain models only) and Buffalo Filter® Smoke Evacuators

(1/case).....DCCM01

Direct Connect Cable for Covidien Electrosurgical Units (certain models only) and Buffalo Filter® Smoke Evacuators

(1/case).....DCCOV01

**Y Adapter**

7/8 in (22 mm) Y Adapter with connectors.  
 (1/case)..... ADP22X22Y



ADP22X22Y

**Surgical Laser Masks**

High efficiency 0.1 micron filtration media surgical masks.  
 (50/case)..... SML0F50



SML0F50

**LaseAdapt® SC Contour TRL Hand Piece Adapter**

Designed to attach directly to the hand piece LaseAdapt® SC series of laser attachments capture laser generated airborne contaminants (LGAC's) and eliminates need to hold a surgical smoke evacuation tube.

7/8 in (22 mm) connector  
 (10/case)..... LA3010EY10



LA3010EY10

**LaseAdapt® ProFractional Therapy Hand Piece Adapter**

Designed for the Sciton ProFractional Therapy Laser System  
 Designed to attach directly to the hand piece, LaseAdapt® SC series of laser attachments capture laser generated airborne contaminants (LGAC's) and eliminates need to hold a surgical smoke evacuation tube.

7/8 in (22 mm) connector  
 (10/case)..... LA3010PF10



LA3010PF10

**LaseAdapt® Hand Piece Adapter Clips**

LaseAdapt® Reuseable Tubing Clips.  
 Designed for the Sciton Contour TRL Erbium Scanner and ProFractional Therapy Laser Systems.  
 (4/case)..... LA3010CL4



LA3010CL4

## Accessories



ARMSTAND

### **Armstand**

Great for office applications. Provides hands-free positioning of the smoke evacuation tubing. Velcro tubing fasteners included.

10 in (25.4 cm) x 10 in (25.4 cm) x 34 in (86.4 cm)

(1/case)..... ARMSTAND

### ViroSafe® 6 Filter

Designed to fit PlumeSafe® Turbo; Porta PlumeSafe® 604  
 Lasts for 6 hours of smoke evacuation time and captures 0.1 to 0.2 micron particles at 99.999% efficiency.

- Dual male ports — 7/8 in (22 mm) and 1-1/4 in (32 mm).  
 (1/case).....VS06001  
 (2/case).....VS06002  
 (4/case).....VS06004



VS06001

### ViroSafe® 6 Twin Port Filter

Designed to fit PlumeSafe® Turbo; Porta PlumeSafe® 604  
 Lasts for 6 hours of smoke evacuation time.

- Twin male ports — 7/8 in (22 mm).  
 (4/case).....VS06T04



VS06T04

### ViroSafe® Extra Long Life Filter

Designed to fit PlumeSafe® Turbo; Porta PlumeSafe® 604  
 Lasts for 18 hours of smoke evacuation time.

- Dual male ports — 7/8 in (22 mm) and 1-1/4 in (32 mm).  
 (2/case).....VSXLL02  
 (4/case).....VSXLL04



VSXLL02

### ViroSafe® Extra Long Life Twin Port Filter

Designed to fit PlumeSafe® Turbo; Porta PlumeSafe® 604  
 Lasts for 18 hours of smoke evacuation time.

- Twin male ports — 7/8 in (22 mm).  
 (1/case).....SING-VSXLLT  
 (2/case).....VSXLLT02  
 (4/case).....VSXLLT04



SING-VSXLLT

## Filters - For Buffalo Filter® Evacuators



VSVET01



SING VSEY



VSEY1-4



PRFIL20

### ViroSafe® Veterinary Filter

Designed to fit PlumeSafe® Turbo; Porta PlumeSafe® 604  
 Lasts for 24 hours of smoke evacuation time and captures 0.1 to 0.2 micron particles at 99.999% efficiency.  
 Dual male ports — 7/8 in (22 mm) and 1-1/4 in (32 mm)  
 Most economical choice for animal hospitals and clinics.  
 (1/case)..... VSVET01

### ViroSafe® Erbium: YAG Filter

Designed to fit PlumeSafe® Turbo; Porta PlumeSafe® 604  
 Specifically designed for use with the Erbium: Yag laser applications.  
 Lasts for 12 hours of smoke evacuation time when used with pre-filters BFEY04PF and captures particles 0.1 to 0.2 micron particles at 99.999% efficiency.  
 Dual male ports — 7/8 in (22 mm) and 1-1/4 in (32 mm).  
 (1/case)..... SING VSEY

### ViroSafe® Erbium: YAG Kit

Designed to fit Erbium: Yag laser applications  
 Using Erbium: YAG pre-filters helps to protect the efficacy of the ViroSafe® Erbium: YAG main filter (ensuring that it lasts for 12 hours of smoke evacuation time).  
 The pre-filter has a 1-3/8 in (35 mm) male port at each end—one to attach to the 1-1/4 in (32 mm) opening on the Main Erbium: YAG filter and another to attach to a 1-3/8 in (35 mm) tubing set.  
 Efficiency:  
 Main Filter: captures particles 0.1 to 0.2 micron particles at 99.999% efficiency  
 Pre-filter: 0.3–0.5 micron filtration  
 Usage Time  
 Main Filter: 12 hours  
 Pre-filter: 1–3 procedures  
 (1 Main Filter, 4 Pre-filters) ..... VSEY1-4

### Pre-filter

Not available in the United States  
 Pre-filter, Single Use  
 (20/case)..... PRFIL20



### ViroSafe® Odor / Hair Removal Filter

Designed to fit PlumeSafe® Turbo; Porta PlumeSafe® 604  
 Ideal for procedures such as laser hair removal that create malodorous smoke and gases.

Lasts for 24 hours of smoke evacuation time and captures 0.1 to 0.2 micron particles at 99.999% efficiency.  
 Dual male ports — 7/8 in (22 mm) and 1-1/4 in (32 mm).  
 (1/case)..... VSOH001  
 (2/case)..... VSOH002



VSOH001

### ViroSafe® Pre-Filter

Designed to fit ViroSafe® main filter  
 Single port pre-filter may be attached to a ViroSafe® main filter to help capture small amounts of liquid and particulate to protect and maintain its efficacy. This pre-filter should be changed after every use.

(10/case).....BFPF7/8-10



BFPF7/8-10

### ViroSafe® 12 Filter

Designed to fit PlumeSafe® 1202 (discontinued)  
 Lasts for 24 hours of smoke evacuation time and captures 0.1 to 0.2 micron particles at 99.999% efficiency.

Dual ports — 7/8 in (22 mm) or 1-1/4 in (32 mm)  
 (1/case)..... VS12D01



VS12D01

### ViroSafe® ViroVac® Filter

Designed to fit ViroVac  
 4 layers of proven filtration gross particulate, ULPA media, activated carbon, and post filter.  
 Last up to 35 hours of smoke evacuation time and captures 0.1 to 0.2 micron particles at 99.999% efficiency.

Hidden ports reduce the risk to caregivers of cross contamination.  
 3-port filter — 1/4 in (6.4 mm), 3/8 in (9.5 mm) and 7/8 in (22 mm)  
 (1/case)..... VS353  
 (2/case)..... VS35302  
 (4/case)..... VS35304



VS353

### ViroSafe® VisiClear® Filter

Designed to fit VisiClear  
 Safeport Technology prevents the clinician from accidental touching an exposed port when not in use. Customized filter life for acute care applications.

Lasts for up to 35 hours of smoke evacuation time and captures 0.1 to 0.2 micron particles at 99.999% efficiency.  
 3-port filter — 1/4 in (6.4 mm), 3/8 in (9.5 mm) and 7/8 in (22 mm).  
 (1/case)..... VS135  
 (2/case)..... VS1352  
 (4/case)..... VS1354



VS135

## Filters - For Wall & Portable Suction Systems



BILF150



BILF200

### **BILF150 Multi-Use In-Line Filter**

Captures particulate before it enters wall suction systems.

Ideal for connection to wall suction port.

ULPA rated media, 0.1 to 0.2 micron.

Economical and easy to use.

As recommended by AORN, surgical smoke should be filtered before it reaches the wall to protect suction systems.

(10/case)..... BILF150

### **BILF200 Multi-Use In-Line Filter**

Captures particulate before it enters wall suction systems.

Ideal for connection to canister tree

ULPA rated media, 0.1 to 0.2 micron.

Economical and easy to use.

Single 1/4 in (6.4 mm) to 3/8 in (9.5 mm) detached tube.

(10/case)..... BILF200

Buffalo Filter® offers an expansive array of filters for OEM and Competitive manufacturer's of surgical smoke evacuators.

We have replacement filters for the following manufacturers:

**Berchtold:** A series of replacement filters designed for the Berchtold Phoenix and TeleVac.

**ConMed:** Replacement filters for the CMIS, ConMed Aspen Vac and Hyfre-VAC filters

**Cooper Surgical:** Replacement pre-filters and filters for Cooper Surgical System 6080

**EDGE:** Replacement Pre-filters and filters for EDGE S.A.F.E. System

**QuantaVac:** Replacement filters for QuantaVac System

**Stryker:** Replacement filters for StrykeVac, StrykeVac 3 and Neptune 2 Ultra

**Stackhouse:** Replacement pre-filters and filters for Stackhouse ES-2000, LFA-100, MiniVac, AirSafe VersaVac and Point OneSystem

**Surgimedics:** Replacement pre-filters and filters for Surgimedics

**TRUMPF:** Replacement filters for TRUMPF EasyVac

**Valleylab:** Replacement pre-filters and filters for Valleylab Optimumm, Airforce, ValleyVac

Please cross-reference the manufacturer's filter model number below to the equivalent Buffalo Filter® replacement filter for that system.

### Berchtold TeleVac & TeleVac LT

*Replaces Berchtold TELEVAC LT and Surgimedics 901428*

Lasts for 8 hours of smoke evacuation time.

7/8 in (22 mm) port.

(4/case).....BTLD004

### Berchtold Phoenix XS or X3 Filter

*Replaces Berchtold TELEVAC XS/X3*

Lasts for 8 hours of smoke evacuation time.

7/8 in (22 mm) port.

(4/case).....BTLDXS04



BTLD004



BTLDXS04



BSUCF03



BFE20004

## Filters - For Competitive Replacement



VSSV505



VSSV301



BSPF\_7-8-30

### **StrykeVac 1 & 2 ViroSafe® Filter**

*Designed to fit Integrated StrykeVac Smoke Evacuation System*

Lasts up to 24 hours of smoke evacuation time.

4-port filter — 1/4 in (6.4 mm),

3/8 in (9.5 mm), 7/8 in (22 mm) and 1-1/4 in (32 mm).

(1/case).....VSSV505

(2/case).....VSSV50502

### **StrykeVac 3 ViroSafe® Filter**

*Designed to fit StrykeVac 3 Smoke Evacuation System*

Lasts up to 24 hours of smoke evacuation time.

3-port filter — 1/4 in (6.4 mm),

3/8 in (9.5 mm) and 7/8 in (22 mm).

(1/case).....VSSV301

(2/case).....VSSV302

(4/case).....VSSV304

### **Surgimedics 7/8 in (22 mm) Pre-filter**

*Replaces Cooper 52560, 6081; Surgimedics 901202 pre-filter*

7/8 in (22 mm) port.

(30/case).....BSPF\_7-8-30

**TRUMPF ViroSafe® Filter (EasyVac Filter for TRUMPF EasyVac)**

*Designed to fit TRUMPF EasyVac*

Lasts for 8 hours of smoke evacuation time.

3-port filter — 1/4 in (6.4 mm), 3/8 in (9.5 mm)

and 7/8 in (22 mm).

(1/case).....VSTR08

(4/case).....VSTR0804



VSTR08

**Smoke Evacuator Filter for Stryker® NEPTUNE® 2 and Neptune 3**

*Designed to fit Stryker® NEPTUNE® 2 and Stryker® NEPTUNE® 3*

3-port filter — 1/4 in (6.4 mm), 3/8 in (9.5 mm)

and 7/8 in (22 mm).

(1/case)..... VSNEP01

(4/case)..... VSNEP04



VSNEP01

# System 5000



60-8005-002



60-8030-001

## System 5000™ Electrosurgical Unit (ESU)

The standard in consistent energy delivery, the System 5000™ unites proprietary dynamic response technology with an array of specialty modes for desired clinical effect.

### System 5000™ ESU

System 5000™ ESU, 100V - 240V (Symbols Front Panel) 60-8005-002

System 5000™ ESU, 100V - 240V ..... 60-8005-003

Includes a System 5000™ – 100V to 240V ESU, Mobile Pedestal, Upper Storage Basket, Lower Storage Basket, Monopolar Footswitch, Bipolar Footswitch (Symbols Front Panel) ..... 60-8015-SYS

Includes a System 5000™ – 100V to 240V ESU, Mobile Pedestal, Upper Storage Basket, Lower Storage Basket, Monopolar Footswitch, Bipolar Footswitch (English Front Panel) ..... 60-8018-SYS

### Mobile Pedestal

Mobile Pedestal including Upper and Lower Storage Baskets ..... 60-8040-001

### Footswitches

Monopolar Footswitch with 15 ft. cable ..... 60-6700-001

Bipolar Footswitch ..... 60-5103-001

### Basket

Saddlebag Lower Basket ..... 60-8041-001

### Stacking Adapter

Adapter allows two System 5000™ ESUs to be mounted on a Mobile Pedestal ..... 60-8030-001

### Manuals / CD

Operator's Manual, System 5000™ ESU ..... 60-8016-ENG

In-Service CD, System 5000™ ESU ..... 60-8026-001

In-Service DVD, System 5000™ ESU ..... 60-8026-DVD

Service Manual, System 5000™ ESU ..... 60-8017-ENG

## System 2450™ Electrosurgical Unit (ESU)

The System 2450™ provides state-of-the-art innovation in an easy-to-use format. Simple on the outside, yet sophisticated and powerful on the inside.

### System 2450™ ESU

System 2450™ ESU, 220V.....	60-2450-220
System 2450™ ESU, 230-240V .....	60-2450-230
System 2450™ Cart .....	60-7152-001

### Footswitches

Monopolar Footswitch with 15 ft. cable .....	60-6700-001
Bipolar Footswitch .....	60-5103-001

### Stacking Adapter

Stacking Adapter for System 2450.....	60-6963-001
---------------------------------------	-------------

### Manuals / CD

Operator's Manual, System 2450™ ESU .....	60-2451-ENG
In-Service CD, System 2450™ ESU .....	60-2453-001
Service Manual, System 2450™ ESU.....	60-2454-ENG

### Universal ESU Cart

Assembled Cart .....	60-7152-001
----------------------	-------------



60-2450-100



60-7152-001

# HelixAR™ System



60-8800-SYS



60-8480-001



60-8849-001

## HelixAR™ ElectroSurgical Generator with Argon Beam Coagulation (ABC®)

The HelixAR™ combines the advanced specialty modes of a premium ESU with the benefits of CONMED's latest ABC® Technology and is intended for use in both open and laparoscopic procedures.

### HelixAR™ System

HelixAR™ System, ABC® Generator.....	60-8800-001
Cart .....	60-8432-001

### Footswitches

ABC® Single Pedal Footswitch, 15'.....	60-8475-001
ABC® Single Pedal Footswitch, 30'.....	60-8470-001
HelixAR™ Wireless Footswitch Kit (Monopolar & ABC® Footswitch, AA Batteries, Receiver/Antenna, Operator's Manual*) .....	60-8480-001
Monopolar Dual Pedal Footswitch, 15'.....	60-6700-001
Bipolar Single Footswitch, 15'.....	60-5103-002

### Stacking Adapter

Adapter allows System 5000™ ESUs to be mounted to HelixAR on a Mobile Pedestal .....	60-8849-001
--	-------------

\* Assembly required. Refer to Wireless Footswitch Operator's Manual for more information.



## Dispersive Electrodes

CONMED's Dispersive Electrodes are globally renowned for their safety, quality, and comfort. With three brands of dual-and single-foil options, CONMED suits a multitude of patients, technologies, and budgets.

### SureFit™ Dual Dispersive Electrodes

SureFit™ Dual Dispersive Electrode (for patients > 4.8 lbs.),  
Single use, Pre-attached 10' (3.05m) Cable,  
100/case, 25/box ..... 410-2000

SureFit™ Dual Dispersive Electrode (for patients > 4.8 lbs.),  
Single use, Pre-attached 15' (4.575m) Cable,  
100/case, 25/box ..... 410-2100

SureFit™ Dual Dispersive Electrode (for patients > 4.8 lbs.),  
Single use, without Cable, resealable, 5-pack pouch  
(use reusable cable # T229), 100/case, 5/pkg ..... 410-2200

### ThermoGard® Plus ABC® Dispersive Electrodes

Adult Dual Dispersive Electrode (for patients >15 kg),  
Single use, Pre-attached 10' (3.05m) Cable, 40/case 1/pkg ..... 7-382

Pediatric Dual Dispersive Electrode (for patients 5-15 kg),  
Single use, Pre-attached 10' (3.05m) Cable, 40/case 1/pkg ..... 7-383

Adult Single Dispersive Electrode (for patients >15 kg),  
Single use, Pre-attached 10' (3.05m) Cable, 40/case 1/pkg ..... 7-384

### ThermoGard® Dispersive Electrodes

Adult Dual Dispersive Electrode (for Patients >15 kg), Single Use,  
Pre-attached 10' (3.05m) Cable, 80/case 1/pkg ..... 51-7310

Adult Dual Dispersive Electrode (for Patients >15 kg), Single use,  
without Cable (use cable T-229), 80/case 1/pkg ..... 51-7410

### MacroLyte® Dispersive Electrodes

Adult Single Dispersive Electrode (for patients >15 kg), Single use,  
Pre-attached 10' (3.05m) Cable, 100/case, 25/box ..... 400-2100

Adult Single Dispersive Electrode (for patients >15 kg), Single use,  
without cable, resealable 5-pack pouch (use reusable cable # T229),  
100/case, 20/box, 5/pkg ..... 400-2700

Pediatric Single Dispersive Electrode (for patients 5-15 kg), Single use,  
Pre-attached 10' (3.05m) Cable, 100/case, 25/box ..... 425-2200

Pediatric Dual Dispersive Electrode (for patients 5-15 kg), Single use,  
Pre-attached 10' (3.05m) Cable, 100/case, 25/box ..... 425-2508

Premie Single Dispersive Electrode (for patients < 5 kg), Single use,  
Pre-attached 10' (3.05m) Cable, 40/case, 10/box ..... 440-2400

Infant Single Dispersive Electrode (for patients 5-15 kg), Single use,  
Pre-attached 10' (3.05m) Cable, 60/case, 15/box ..... 450-2300



SureFit™



ThermoGard®



MacroLyte®

## ABC® Dissecting Probes



### ABC® Dissecting Electrodes

ABC® Technology in contact mode allows surgeons to dissect while employing the benefits of Argon Beam Coagulation. Surgeons can also continue to use ABC® in non-contact mode simply by pulling the ABC® Dissecting Electrodes away from tissue.

Simple to use, ABC® Dissecting Electrodes attach to a CONMED ABC® handpiece to convert from Argon Beam Coagulation to Argon Beam Dissect. By forcing argon gas over an electrode in contact or non-contact mode, ABC® Dissecting Electrodes may provide the following benefits for surgical procedures:

ABC® Dissecting Blade Electrode converts Argon Beam Coagulation to Argon Beam Dissect, 20/Case ..... 139330

ABC® Dissecting Blunt Needle Electrode converts Argon Beam Coagulation to Argon Beam Dissect, 20/Case ..... 139331

### Compatible ABC® Probes/Handpieces

Laparoscopic 10mm ABC® Probe  
For use in Laparoscopy, 10/Case ..... 130342

ABC® Single Function Handpiece  
For use in Open Procedures, 10/Case ..... 130344

ABC® Angled 45° foot control handpiece  
For use in Open Procedures, 10/Case ..... 130345

## ABC® Handpieces and Laparoscopic Probes

Designed for versatility and performance, ABC® Handpieces and Probes enable surgeons to extend the benefits of ABC® Technology to their patients. Each device is carefully designed for optimal clinical performance in a variety of open or laparoscopic procedures.

### Hand Control (Disposable)

- Triple Option Hand Control Handpiece with 10' (3.05m) cord. Allows use of Monopolar Cut, Coagulation and ABC® ..... 130321
- Single Function Hand Control Handpiece with 10' (3.05m) cord\* ..... 130344
- 3" (7.6cm) Bend-a-Beam Single Function Malleable ABC® Hand Control Handpiece with 10' (3.05m) cord ..... 134003
- 6" (15.2cm) Bend-a-Beam Single Function Malleable ABC® Hand Control Handpiece with 10' (3.05m) cord ..... 134006
- 9" (22.8cm) Bend-a-Beam Single Function Malleable ABC® Hand Control Handpiece with 10' (3.05m) cord ..... 134009

### Foot Control (Disposable)

- 45° Angled ABC® Foot Control Handpiece with 10' (3.05m) cord\* ..... 130345

### Foot Control Laparoscopic Probes (Disposable)

- Laparoscopic 10mm ABC® Probe with 10' (3.05m) cord. 28cm working length\* ..... 130342
- Laparoscopic 5mm ABC® Probe with 10' (3.05m) cord. 28cm working length ..... 160655

### Hand Control Laparoscopic Probes (Disposable)

- Laparoscopic 5mm ABC® Probe with 10' (3.05m) cord. 28cm working length ..... 160656
- Laparoscopic 5mm ABC® Probe with 10' (3.05m) cord. 36cm working length ..... 160636
- Laparoscopic 5mm ABC® Probe with 10' (3.05m) cord. 44cm working length ..... 160644



130321  
Triple Option Handpiece



130344  
Single Function Handpiece



134003



134006



134009



130345  
45° Foot Control Handpiece

\*Can be used with ABC® Dissecting Electrodes

## Electrosurgical Pencils



GoldLine®

### GoldLine® Electrosurgical Pencils

CONMED's wide variety of pencils appeal to a wide variety of surgeon preferences. Electrosurgical pencils are available in Push Button, Rocker Switch, and Foot-Control configurations, as well as with stainless steel and UltraClean® electrode options.

#### Push Button, Hand Switch Pencils

UltraClean® Blade, Holster, 10' Cable, 40/case .....	131309A
UltraClean® Blade, Holster, 15' Cable, 40/case .....	131326A
Standard Blade, Holster, 10' Cable, 40/case .....	130309A
Standard Blade, Holster, 15' Cable, 40/case .....	130326A
Standard Blade, Holster, Tip Cleaner, 10' Cable, 40/case .....	130303A
Needle Electrode, Holster, 10' Cable, 40/case .....	130302A
Extended Insulated Blade, Holster, 10' Cable, 40/case.....	138114A

#### Rocker Switch, Hand Switch Pencils

UltraClean® Blade, Holster, 10' Cable, 40/case .....	131307A
UltraClean® Blade, Holster, 15' Cable, 40/case .....	131327A
Standard Blade, Holster, 10' Cable, 40/case .....	130307A
Standard Blade, Holster, 15' Cable, 40/case .....	130327A
Standard Blade, Holster, Tip Cleaner, 10' Cable, 40/case .....	130304A
Needle Electrode, Holster, 10' Cable, 40/case .....	130301A
Ext. Blade 10' (3.05m) Cable, Holster 40/case 1/pkg .....	138115A

#### Foot Control Pencils

UltraClean® Blade, Holster, 10' Cable, 40/case .....	138650A
Needle Electrode, Holster, 10' Cable, 40/case .....	138652A
Blade Electrode, Holster, 10' Cable, 40/case .....	138659A

#### Tip Cleaner

Tip Cleaner, Single Use, Sterile, 40/case .....	138029
---	--------

### Reusable Hand Control Pencils

- GoldLine® Push Button, 1" Blade Disposable, 50 use, 10' (3.05m) Cable  
10/case 1/pkg ..... 130317
- GoldLine® Push Button, 1" Blade Disposable, 50 use, 15' (4.57m) Cable  
10/case 1/pkg ..... 130317-15
- GoldLine® Rocker Switch, 1" Blade Disposable, 50 use, 10' (3.05m) Cable  
10/case 1/pkg ..... 130316
- PowerPoint, 1" Blade Reusable, 50 use, 15' (4.57m) Cable  
10/case 1/pkg ..... 130384

### Pencil Accessories

- Reusable Safety Holster  
10/case 1/pkg .....60-0235-001
- Disposable Safety Holster  
40/case 1/pkg ..... 137668

### ValueBlue™ ElectroSurgical Pencils

- Push-Button Pencil, 1" Stainless Steel Blade, Sterile  
10/case 1/pkg ..... 130402
- Push-Button Pencil, 1" ValueBlue™ Coated Electrode, Sterile  
10/case 1/pkg ..... 130403
- Rocker-Switch Pencil, 1" Stainless Steel, Sterile  
10/case 1/pkg ..... 130404
- Rocker-Switch Pencil, 1" ValueBlue™ Coated Electrode, Sterile  
10/case 1/pkg ..... 130405



## Active Electrodes

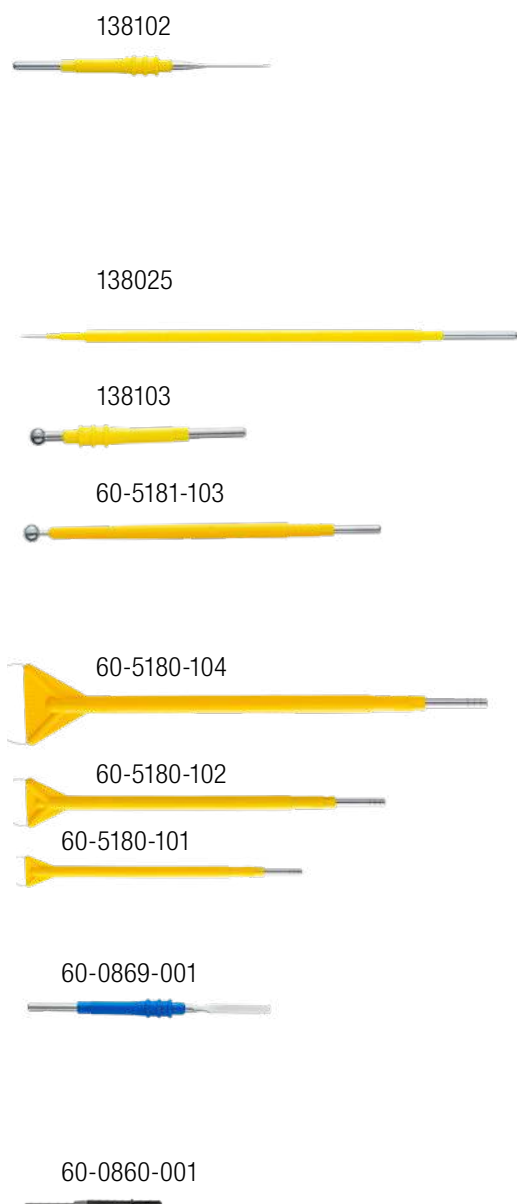

### Disposable Stainless Steel Needles

Needle Electrode with Hex Hub	
40/case 1/pkg .....	138102
Needle Electrode with Extended Insulation; Hex Hub	
40/case 1/pkg .....	138105
6" Needle Electrode with Hex Hub	
40/case 1/pkg .....	138108
6" ENT Needle Electrode with Extended Insulation	
40/case 1/pkg .....	138025

### Disposable Stainless Steel Balls

Ball, 3/16" diameter, with Hex Hub	
40/case 1/pkg .....	138103
Ball, 3mm diameter, 10cm shaft	
5/case 1/pkg .....	60-5181-102
Ball, 5mm diameter, 10cm shaft	
5/case 1/pkg .....	60-5181-103

### Disposable Loops

Loop Excision Electrode, "T" Style, 12x8mm	
5/case 1/pkg .....	60-5180-101
Loop Excision Electrode, "T" Style, 15x10mm	
5/case 1/pkg .....	60-5180-102
Loop Excision Electrode, "T" Style, 20x10mm	
5/case 1/pkg .....	60-5180-104

### Reusable Blades

Straight Blade Electrode, 1" (2.54cm) length; Hex Hub	
6/case 1/pkg .....	60-0869-001

### Reusable Needles

Needle Electrode, Fine; Hex Hub	
6/case 1/pkg .....	60-0860-001

### Reusable Extender

Straight Electrode Extender, .5" (12.7cm)	
5/case 1/pkg .....	138026

### Disposable UltraClean® Blades

1" UltraClean® Blade 50/case 1/pkg .....	139100
1" UltraClean® Blade with Extended Insulation 50/case 1/pkg .....	139104EXT
4" UltraClean® Blade 50/case 1/pkg .....	139112
4" UltraClean® Blade with Extended Insulation 50/case 1/pkg .....	139112EXT
6" UltraClean® Blade 50/case 1/pkg .....	139107
6" UltraClean® Blade with Extended Insulation 50/case 1/pkg .....	139110EXT
1" UltraClean® Blade for ABC® Triple Option Handpiece 10/case 1/pkg .....	139321

### Disposable Stainless Steel Blades

Heavy Flat Blade Electrode with Hex Hub 40/case 1/pkg .....	138100
Standard Flat Blade Electrode with Hex Hub 40/case 1/pkg .....	138101
Flat Blade Electrode with Extended Insulation; Hex Hub 40/case 1/pkg .....	138104
6" Flat Blade Electrode with Hex Hub 40/case 1/pkg .....	138107
6" Flat Blade Electrode with Extended Insulation; Hex Hub 40/case 1/pkg .....	138110
4" Flat Blade Electrode with Hex Hub 40/case 1/pkg .....	138112
3 1/2" Flat Blade Electrode with Hex Hub 40/case 1/pkg .....	138113

### Disposable UltraClean® Needles

1" UltraClean® Needle 50/case 1/pkg .....	139102
1" UltraClean® Needle with Extended Insulation 50/case 1/pkg .....	139105EXT
6" UltraClean® Needle 50/case 1/pkg .....	139108
6" UltraClean® Needle with Extended Insulation 50/case 1/pkg .....	139025EXT

### MicroNeedles

Compatible with electrosurgical pencils that can accommodate an electrode with a 3/32 inch (2.4mm) or 5/32 inch (4mm) shaft.

3cm, 0° MicroNeedle, 10/case .....	138505-10
4cm, 0° MicroNeedle, 10/case .....	138506-10



139100



139112 EXT



139107



138101



138110



138112



139102



139025EXT



138505-10

## Dispersive Electrodes



60-0136-001



60-0137-001



60-5806-001



60-0641-001

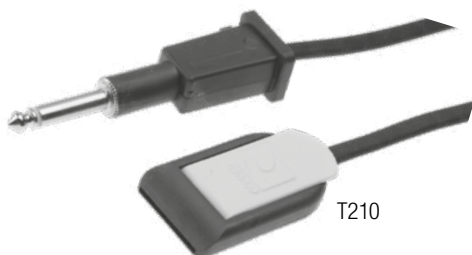

T210

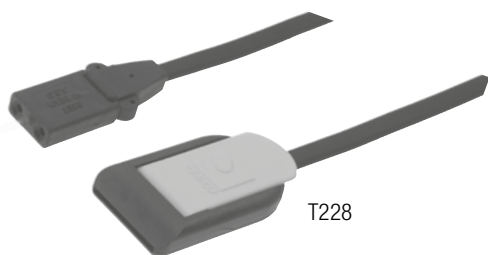

T228



T235



A238

### Reusable Dispersive Electrodes

Adult Reusable Patient Plate; Stainless Steel,  
63 sq. in. (406.48 sq. cm)  
1 each ..... 60-0136-001

Pediatric Reusable Patient Plate; Stainless Steel,  
35 sq. in. (225.82 sq. cm)  
1 each ..... 60-0136-002

### Reusable Cables (for use with reusable dispersive electrodes)

2-wire cable for 60-0136-001 and 60-0136-002 patient plates  
above.  
For use with Aspen, Neomed, BARD EMS 771, 737 and 737XL and  
Ritter Electrosurgical Units; 10' (3.05m) Cable  
1 each ..... 60-0137-001

2-wire cable for 60-0136-001 and 60-0136-002 patient plates  
above.  
For use with CONMED Sabre 180, Sabre 2400, Excalibur, Excalibur  
Plus, Excalibur Plus PC, System 2450™ and System 5000™  
Electrosurgical Units; 10' (3.05m) Cable  
1 each ..... 60-5806-001

### Conductive Gel (for use with reusable dispersive electrodes)

ASPENGEL Conductive Gel, Nonstaining; 8.45 fluid ounce  
12/case 1/pkg ..... 60-0641-001

### Cables for Dispersive Electrodes

Cable for use with Erbe and Elmed generators; 10' (3.05m)  
1 each ..... T210

Cable for use with all ARM-equipped and Valleylab REM-equipped  
generators. Enables pad-to-patient contact quality monitoring;  
10' (3.05m)  
1 each ..... T229

Cable for use with all ARM-equipped and Valleylab REM-equipped  
generators. Enables pad-to-patient contact quality monitoring;  
15' (4.57m)  
1 each ..... T229-5M

Cable for use with CONMED System 6500 and System 7500 ABC®  
10' (3.05m)  
1 each ..... T235

### Dispersive Electrode Adapters and Cables

Dispersive Electrode Adapter. For use with Erbe and Elmed generators  
1 each ..... B210

Dispersive Electrode Adapter. Allows CONMED ABC® generators to use  
Valleylab dual-foil dispersive electrodes  
1 each ..... A238



### Disposable Cords

.09375" Disposable Monopolar Cord (Gray) ..... 60-5168-001

.09375" (2.4mm) receptacle, 10' (3.05m) length  
Single-use, Sterile, 1/pkg, 50/cs

For use with laparoscopy electrodes  
series 60-5158-XXX thru 60-5165-XXX.

4mm Disposable Monopolar Cord (Blue) ..... 60-5168-005

4mm (.15625") receptacle, 10' (3.05m) length  
Single-use, Sterile, 1/pkg, 50/cs

Fits most standard 4mm monopolar connector posts.  
Fits all CONMED disposable scissors, graspers, dissectors,  
DetachaTip, Sensatec and 4mm post laparoscopic electrodes.



60-5168-001



60-5168-005

### Reusable Cables

4mm Reusable Monopolar Cable ..... 60-5169-001

4mm (.15625") pin receptacle, 10' (3.05m) length  
Reusable, Non-sterile, 1 each

Fits most standard 4mm monopolar connector posts.  
Fits all CONMED disposable scissors, graspers, dissectors,  
DetachaTip, Sensatec and 4mm post style laparoscopic electrodes.



60-5169-001

### Footswitch Adapter

#### Active Instrument Adapter – Monopolar

Adapter for foot control monopolar accessories;  
fits Bovie #12 type output sockets

1 each ..... 60-0823-001

Universal Adapter for foot control monopolar accessories;  
fits Bovie #12 type output sockets

1 each ..... 60-6790-001



60-0823-001



60-6790-001

VISUALIZATION



Looking Glass™



Looking Glass™

**Video System**

Looking Glass™ Integrated Surgical Visualization System ..... AV4132

Looking Glass™ Camera Head – 4K 3MOS EYECUP..... AV41CHE

Looking Glass™ Cable Connector Interface ..... AV41CON

Touch Glass Standard Image Capture .....AV41SIC

Touch Glass Content Management System.....AV41CMS

**Light Source**

Electronic Light Guide eLuma .....AV41LG

ELG Dyonics/Wolf Adapter .....AVELG51

ELG Adapter ACMI .....AVELG52

ELG CONMED Threaded Adapter.....AVELG53

Scope to Threaded Adapter .....AVELG53SA

LED Light Console.....LS8000

**Video Cart**

Video Cart, 230VAC .....VP8501

Primary Articulating Arm .....VP8570

Secondary Arm with Keyboard Tray .....VP8571

Shelf Looking Glass™ VP8500 Adapter .....AV8541

Mounting Bracket Looking Glass™ CCI .....AV8542

Retro-kit for Visualization Cart ..... VP8500AV-kit

USB Keyboard for DRSHD-1080P ..... DRS29



AV4132



AV41SIC  
AV41CMS



LS8000



AV41CHE



AV41CON



AV41LG

## Camera Systems



IM8000 True HD3  
MOS Camera Control Unit



True HD 3MOS "Eyecup" Camera Head



True HD 3MOS "Cartridge" Camera Head



True HD 3MOS "Urology" Camera Head

### IM8000 True HD 3MOS (3-Chip CMOS) Camera Control Unit

- Vivid Visualization - CMOS chip sensors provides increased light sensitivity, crisp resolution and the most natural color spectrum for advanced surgical procedures.
- Fully Autoclavable- All three camera heads are designed to be autoclavable, which is the most cost-effective form of sterilization.
- Durable Design -For increased durability and reliability, these camera heads feature our proprietary ShockFlexprism mounting designed to limit surprises in the OR caused by faulty equipment and ensure a long life span

True HD 3MOS Camera Control Unit..... IM8000

Autoclavable True HD 3MOS "Eyecup" Camera Head..... IM8120

Autoclavable True HD 3MOS "Cartridge" Camera Head..... IM8121

Autoclavable True HD 3MOS "Urology" Camera Head ..... IM8123

**All-In-One Integrated 4K Camera System**

- The 3-chip CMOS sensors deliver an increased color spectrum, clarity and resolution while the direct LED light source delivers consistent light output for optimal clarity
- The Trinity™ 4K combines the camera controller, light source and image capture into one compact console that frees up space and simplifies wire management Flexibility of movement
- An optional wireless tablet allows OR staff access to the system remotely, so adjustments can easily be made from outside the sterile field

Trinity™ 4K Camera Control Unit .....	81-10-4010
Trinity™ 4K Camera Head, 3CMOS "Eyecup" .....	81-10-4100
Trinity™ Tablet User Interface .....	81-10-1000



81-10-1000



81-10-4010



81-10-4100

## 3DHD Vision Systems



IM8000 True HD3  
MOS Camera Control Unit



3DHD Dual Channel  
Camera Head



3DHD 2D  
Camera Head



Coupler F-27



3DHD Overwear 3D Glasses



3DHD Dual Channel  
Endoscope 10mm 30°



3DHD Dual Channel  
Endoscope 10mm 0°

### 3DHD Camera Controller

3DHD Camera Controller ..... 8170-6

### 3DHD LCD Display

3DHD LCD Display – 32” ..... 8272-19

### 3DHD Camera Heads

3DHD Dual Channel Camera Head. .... 8170-9

### 3DHD 3D Glasses

3DHD Overwear 3D Glasses (box of 5) ..... 8272-16

### Autoclavable Stereo Endoscopes

#### Dual Chanel Bariatric

3DHD Dual Channel Endoscope 10mm 0°,  
Useful length 415mm ..... 8191-11

3DHD Dual Channel Endoscope 10mm 30°,  
Useful length 415mm ..... 8191-12

#### Dual Channel Standard length

3DHD Dual Channel Endoscope 10mm 0°,  
Useful length 300mm ..... 8191-13

3DHD Dual Channel Endoscope 10mm 30°,  
Useful length 300mm ..... 8191-14



### LS8000 Direct LED Light Source

- Energy-efficient, LED technology consumes less energy than Xenon style bulbs and can last up to 40 times longer than many other light source types. This avoids the constant replacement of light bulbs which can become costly and time consuming for the hospital staff.
- Includes light guide detection feature for automatic standby when the light guide is removed from the receptacle. This avoids excessive heat at the tip of the scope that may engage the drape and cause safety issues during the procedure.
- Light box console Includes new informative display with intuitive icons for ease-of-use in operating.
- Ideal for frequent on-off cycling with low burn out rates.



LS8000 Direct LED Light Source

Direct LED Light Source..... LS8000

### High Definition Compatible Xenon Light Source

The HD Compatible 300 Watt Xenon Light Source from CONMED is a standalone, user-friendly light source that provides optimal light output so even the most challenging surgical cases are adequately illuminated.

- OLED window display with multi-function read out » HD Camera control connection allows surgeon to safely turn bulb stand-by on/off via the remote camera head button
- HD Camera communication link allows light output to automatically adjust to optimal light intensity when using the IM4000 HD Camera
- Universal light guide receptacle that accommodates both long and short light guide adapters
- Auto bulb-saver feature designed to extend useful life of bulb when light source is not in use
- Easy access bulb replacement
- Locking feature to keep light guide securely in place
- Compatible with ConMed's SMART OR Nurse's Assistant OR Control and Integration Systems



LS7700 HD Compatible Light Source

300 Watt Xenon Light Source ..... LS7700

## Medical Monitors



LMD-X310MD



VP4932



LMD-2765MD

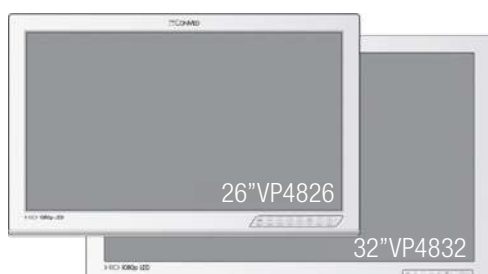

LCD Monitor Cover

### 4K MONITORS

CONMED's 4K System provides dependable performance and a vivid image, allowing surgeons the depth and clarity needed in the OR.

SONY 31" Medical Monitor ..... LMD-X310MD

4K UHD Monitor, 32" ..... VP4932

### HD LED Monitor

SONY 27" Medical Monitor ..... LMD-2765MD

26" and 32" HD LED Backlit Medical Grade Monitors & Wireless System

26" High Definition LED Monitor ..... VP4826

32" High Definition LED Monitor ..... VP4832

### LCD Monitor Covers

Protects your investment when not in use

Monitor Cover, 26" ..... VP4826C

Monitor Cover, 32" ..... VP4832C

## CMS9000

### Content Management System

With features like multi-channel Full HD recording, wireless connectivity, integration with hospital electronic health record (EHR) networks, live streaming, an improved iOS app (iPad and iPhone) and more, the CMS9000 represents CONMED's next generation of high definition image capture system that's designed to improve how hospitals manage surgical footage both in and out of the OR.

#### Features

- Wi-Fi Connection to Hospital EMR Networks
- Integrated iPad/iPhone App
- Live, Full-HD Streaming over ip
- Integrated Data Security
- Customizable User Profiles

CMS9000 Content Management System .....	CMS9000
CMS9000 Software Upgrade with Installation Card .....	CMS30
15" LCD Medical Touch Screen Monitor .....	CMS34
CMS34 Stand .....	CMS34-STD

## USB300

The USB300 is the medical industry's easiest, most affordable high-definition recorder. Record up to two weeks of HD video on the internal hard drive or record directly to a convenient USB flash drive.

#### Features

- high-definition video
- Record up to two weeks of HD video on the internal hard drive
- Can record directly to a convenient USB flash drive
- Steel case and fluid resistant front panel

USB300, HD Medical Video Recorder .....	USB300
---	--------



CMS9000  
Content Management System



15" LCD Medical Touch Screen Monitor



USB300

## Printer



Sony UP-DR80MD Full Page Color Printer

### Sony Full Page Color Printer

The UP-DR80MD is the flagship printing option for HD image capture systems. The UP-DR80MD prints in letter or A4 format and is medical grade. The UP-DR80MD is ideal for all applications where outstanding image quality and accurate color reproduction are essential. This fast and reliable dye sublimation printer is compact enough for video cart integration.

#### Features

- Premium, photo-realistic prints
- High-speed printing
- Compact size and stylish design
- Fits well on surgical video carts
- USB 2.0 connection
- Self-laminating roll media
- Easy to operate
- Letter or A4 Paper Size/50 sheet capacity

#### Specifications

- Power Requirements: 100 – 240 VAC, 50/60 Hz, 3.4 A to 1.4 A
- Controller: 12.5" h x 8.13" w x 16.75" l (31.7 cm w x 20.7cm h x 42.5cm d)
- Weight: 25.3 lbs. (11.5 kg)

Sony UP-DR80MD Full Page Digital Color Printer ..... UP-DR80MD  
 Color Print Pack, Letter Size, 100 Sheets ..... UPC-R81MD  
 Color Print Pack, A4 Size, 100 Sheets ..... UPC-R80MD

### VP8501 Video Cart

The next generation video cart is like nothing else on the market. The VP8500 Video Cart provides your OR with clean lines, new features and added flexibility. Providing a platform for High Definition or Enhanced Definition equipment, the VP8500 is designed to be as modern looking as the equipment on its shelves.

Video Cart, Standard, INT ..... VP8501

### NEW - VP8500 Accessories

(Only compatible with the new white VP8501)

### Monitor arms

Primary Articulating Arm (supports monitors up to 18Kg) ..... VP8570

Secondary Articulating Arm with Keyboard Tray  
(supports monitors up to 7Kg) ..... VP8571

### Suction & Irrigation

10K Pump Holder ..... VP8572

### CO<sub>2</sub>

CO<sub>2</sub> Holder, Dual Tank Holder ..... VP8574

CO<sub>2</sub> Holder, Single Tank Holder ..... VP8575

Tank Wrench with Magnetic Base ..... VP8580

### Camera accessories

Storage Drawer ..... VP8576

Camera Head Holder ..... VP8577

Trinity™ Tablet Arm ..... VP8581

### Foot pedal holder and basket

Footswitch Bin ..... VP8578

17" Wide shelf option ..... VP8540

### Previous VP8500 Monitor Mounts CART

(Only compatible with the older gray VP8500 carts)

Main Flat Panel Articulating Arm  
(supports monitors up to 14Kg) ..... VP8532

Articulating Arm 26" monitor  
(supports monitors up to 11Kg) ..... VP8525

Heavy Panel, Flat Panel Post Mont ..... VP8565

Secondary Monitor Mount  
(supports monitors up to 13Kg) ..... VP8520



VP8501

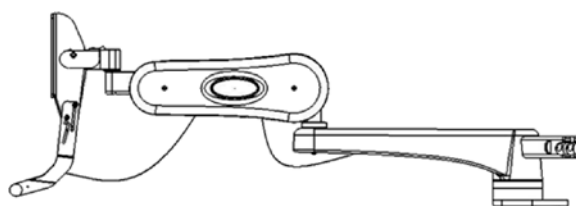

VP8570

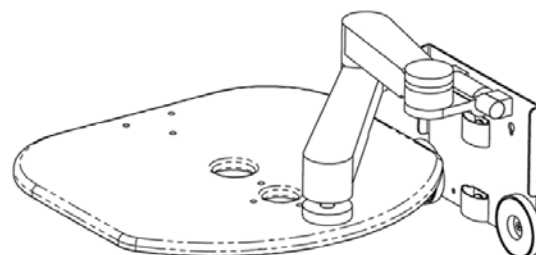
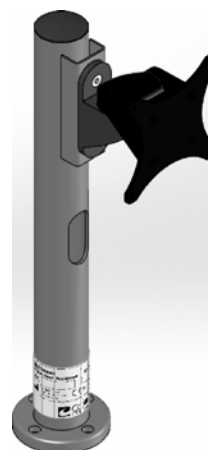

VP8578

# Laparoscopes

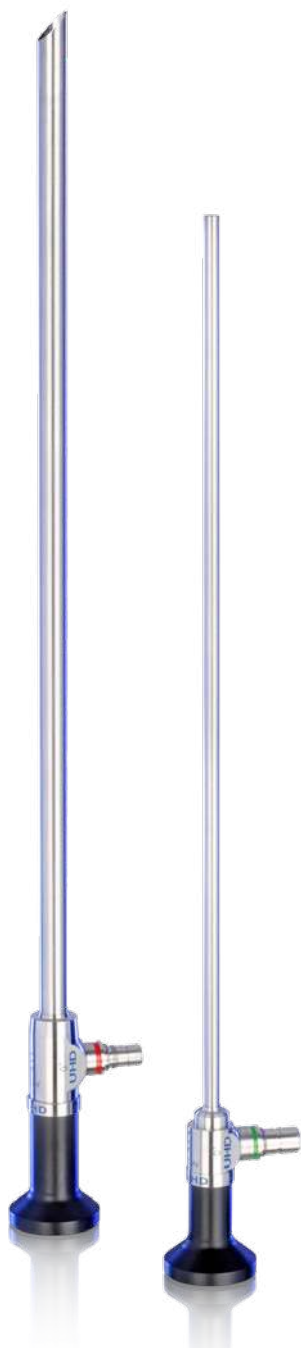

Ultra-High Definition Laparoscopes

## Ultra High Definition (UHD) Laparoscopes

Upgrade your OR to our next generation of clinical visualization. CONMED's third generation Ultra-High Definition Laparoscopes have features designed to enhance image clarity and sharpness for improved viewing of anatomical structures.

### 5.5mm UHD Autoclavable Laparoscopes

#### Standard Length (Working length 325mm)

5.5mm UHD Laparoscope, Standard Working Length, 0° .....	UHD5500
5.5mm UHD Laparoscope, Standard Working Length, 30° .....	UHD5530

#### Extended Length (Working Length 450mm)

5.5mm UHD Laparoscope, Extended Working Length, 30° .....	UHD5530XL
5.5mm UHD Laparoscope, Extended Working Length, 45° .....	UHD5544XL

### 10mm UHD Autoclavable Laparoscopes

#### Standard Length

10mm UHD Laparoscope, Standard Working Length, 0° .....	UHD1000
10mm UHD Laparoscope, Standard Working Length, 30° .....	UHD1030

#### Extended Length

10mm UHD Laparoscope, Extended Working Length, 0° .....	UHD1000XL
10mm UHD Laparoscope, Extended Working Length, 30° .....	UHD1030XL
10mm UHD Laparoscope, Extended Working Length, 45° .....	UHD1044XL

## HD Autoclavable Laparoscopes

Autoclavable Laparoscopes offer excellent optical performance with state-of-the-art optical systems. Sapphire lenses ensure durability, decreasing costly repairs.

### 5.5mm HD Autoclavable Laparoscopes Standard Length (Working length 325mm)

5.5mm HD Laparoscope, Standard Working Length, 0° .....	HD5500
5.5mm HD Laparoscope, Standard Working Length, 30° .....	HD5530
5.5mm HD Laparoscope, Standard Working Length, 45° .....	HD5544

### Extended Length (Working Length 450mm)

5.5mm HD Laparoscope, Extended Working Length, 0° .....	HD5500XL
5.5mm HD Laparoscope, Extended Working Length, 30° .....	HD5530XL
5.5mm HD Laparoscope, Extended Working Length, 45° .....	HD5544XL

### 10mm HD Autoclavable Laparoscopes Standard Length

10mm HD Laparoscope, Standard Working Length, 0° .....	HD1000
10mm HD Laparoscope, Standard Working Length, 30° .....	HD1030
10mm HD Laparoscope, Standard Working Length, 45° .....	HD1044



5.5mm Eyecup HD  
Autoclavable Laparoscope



5.5mm Eyecup HD  
Autoclavable Extended  
Length Laparoscope



10mm Eyecup HD  
Autoclavable Laparoscope

## Light Guides



C3278



LG1050



LG1090

### Universal Light Guides

- Autoclavable
- Superior light transmission
- Lightweight and flexible
- Universal fittings

### Non-Transparent

- both sides Universal

5mm x 3m Universal Light Guide, Non-Transparent..... C3278

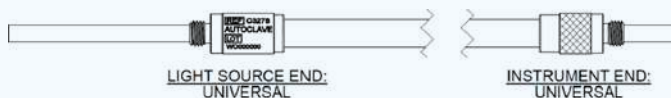

### Translucent Blue

Light Source side : Olympus fitting & Scope side : Universal

5mm x 3m Autoclavable Light Guide, Translucent Blue ..... LG1050

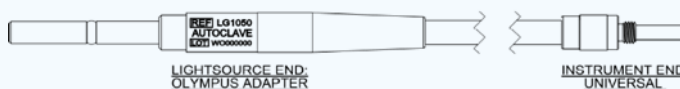

### Translucent Blue 90°

» Light Source side : Olympus fitting & Scope side : ACMI fitting

5mm Autoclavable Light Guide, 90 degree,  
Translucent Blue ..... LG1090

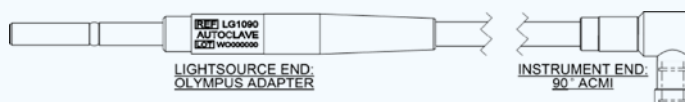



**Light Source Fittings** (to complete C3278 Universal Light Guide)

Wolf, Dyonics Light Source Fitting .....	7455
ACMI Light Source Fitting .....	7456
Storz Light Source Fitting .....	7457
Olympus Light Source Fitting .....	7458
Replacement Scope Fiber Post Adapters.....	7513

**Scope Fittings** (to complete C3278 & LG1050 Universal Light Guides)

Wolf, Dyonics Scope Fitting .....	7451
ACMI Scope Fitting .....	7452
Storz, Olympus Scope Fitting .....	7453

**NOTE:**

When ordering a light, make sure to order appropriate fittings to go with it :

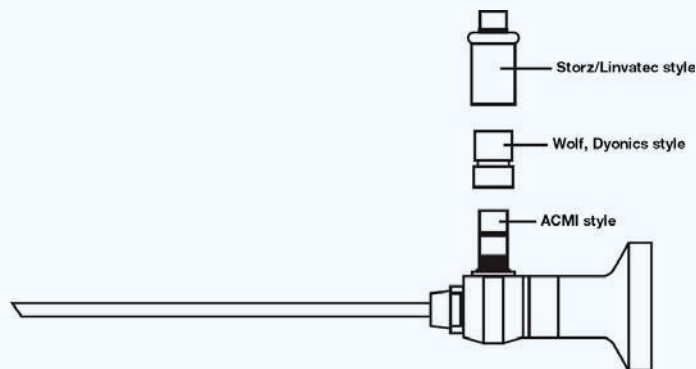

## Sterilization Trays

### VP100X Sterilization Tray Series

CONMED's tray product portfolio will allow you to properly store and reprocess a variety of our 2DHD autoclavable devices that can be used in multi-specialty, minimally invasive surgical procedures. These components include camera heads, scopes, sheaths, bridge systems, cannula's and light guides.



Video Extended Length Tray .....VP1003  
 » Scopes and Light Guides

Scopes with an outer diameter not less then 5.5mm or greater than 10mm with lengths no greater than 530mm

Video Tray Single Level .....VP1005  
 » Camera heads, Scopes, Sheaths, Cannula's and Bridge Systems  
 Scopes, Sheaths, Cannulas and Bridge Systems with internal diameters no less than 2.3mm, outer diameter not less than 2.3mm or greater than 10mm, and with lengths no greater than 404mm may be sterilized in this tray.

Video Arthroscopy Tray .....VP1006  
 » 2.9mm and 4.0mm Arthroscopes.

Scopes with diameters no less than 2.9mm or greater than 4mm, with lengths no greater than 233mm may be sterilized in this tray.

Video Laparoscope Tray .....VP1007  
 » 5.5mm and 10mm Laparoscopes.

Scopes with diameters no less than 5.5mm or greater than 10mm, with lengths no greater than 404mm may be sterilized in this tray.

3DHD Camera System Tray .....VP1008  
 » 3DHD System components including camera heads, scopes and light guide in this two section tray.

- Bottom will accommodate 3DHD Dual Channel Endoscope, Stereo Endoscope, 2DHD Single Channel Laparoscope.
- Top portion will accommodate both 3DHD camera head models and 2DHD camera head and light guide.

3DHD Rigid Scope Sterilization Tray .....VP1009



# Product Index

Catalog #	Page #	Catalog #	Page #	Catalog #	Page #
1-1010	36	3-1003	34	60-5103-001	70, 71
1-1027	36	3-1004	34	60-5103-002	72
1-7001	22	3-1005	34	60-5168-001	81
1-7002	22	3-1006	34	60-5168-005	81
1-7003	22	3-1008	34	60-5169-001	33, 81
1-7005	22	3-1009	34	60-5180-101	78
1-7007	22	3-1010	34	60-5180-102	78
1-7008	22	3-1011	34	60-5180-104	78
1-7009	22	3-1012	34	60-5181-102	78
1-7011	22	3-1017	34	60-5181-103	78
1-7013	22	3-1018	34	60-5272-027	40
1-7016	23	3-1019	34	60-5272-032	40
1-7017	23	3-1028	34	60-5272-127	40
1-7018	23	3-4301	34	60-5272-132	40
1-7019	23	3-4304	34	60-5272-227	41
1-7020	23	3-4305	34	60-5272-232	41
1-7021	23	3-4306	34	60-5272-927	41
1-7024	23	3-4307	34	60-5274-027	40
1-7025	23	3-4308	34	60-5274-032	40
1-7028	23	3-4311	34	60-5274-044	40
1-7044	22	3-4312	34	60-5274-127	40
1-7045	22	3-4317	34	60-5274-132	40
1-7052	23	3-4318	34	60-5274-144	40
1-7055	23	3-4319	34	60-5274-227	41
1-7057	23	3-4328	34	60-5274-232	41
2-1003	35	3-4329	34	60-5274-244	41
2-1004	35	3-4343	34	60-5274-932	41
2-1005	35	7-382	73	60-5274-944	41
2-1008	35	7-383	73	60-5806-001	80
2-1009	36	7-384	73	60-6000-130	41
2-1014	35	51-7310	73	60-6001-108	41
2-1017	36	51-7410	73	60-6001-110	41
2-1018	36	60-0136-001	80	60-6001-203	41
2-1019	35	60-0136-002	80	60-6001-205	41
2-1028	35	60-0137-001	80	60-6001-360	41
2-4301	35	60-0235-001	77	60-6001-361	41
2-4304	35	60-0641-001	80	60-6002-301	41
2-4305	35	60-0823-001	81	60-6002-302	41
2-4307	35	60-0860-001	78	60-6002-305	41
2-4308	36	60-0869-001	78	60-6002-308	41
2-4317	36	60-2450-220	71	60-6002-309	41
2-4318	36	60-2450-230	71	60-6005-500	41
2-4319	35	60-2451-ENG	71	60-6005-505	41
2-4328	35	60-2453-001	71	60-6010-000	40
		60-2454-ENG	71	60-6010-001	40

## Product Index

Catalog #	Page #	Catalog #	Page #	Catalog #	Page #
60-6010-002	40	60-7580-005	51	3031	42
60-6010-003	40	60-7610-001	51	3036	42
60-6010-005	40	60-7670-001	51	3036R	42
60-6010-020	40	60-8005-002	70	7451	97
60-6010-022	40	60-8005-003	70	7452	97
60-6035-001	37	60-8015-SYS	70	7453	97
60-6035-001W	37	60-8016-ENG	70	7455	97
60-6035-002	37	60-8017-ENG	70	7456	97
60-6035-003	37	60-8018-SYS	70	7457	97
60-6035-004	37	60-8026-001	70	7458	97
60-6035-005	37	60-8026-DVD	70	7513	97
60-6035-431	37	60-8030-001	70	8170-6	88
60-6035-433	37	60-8040-001	70	8170-9	88
60-6050-001	15	60-8041-001	70	8191-11	88
60-6050-002	15	60-8432-001	72	8191-12	88
60-6050-097	15	60-8470-001	72	8191-13	88
60-6050-098	15	60-8475-001	72	8191-14	88
60-6050-099	15	60-8480-001	72	8272-16	88
60-6080-000A	28	60-8585-230	47	8272-19	88
60-6085-200A	28	60-8590-001	47	8935	42
60-6085-201A	28	60-8596-001	47	16020	24
60-6085-202A	28	60-8597-001	47	16022	24
60-6085-203A	28	60-8800-001	72	16050	24
60-6700-001	70	60-8849-001	72	16052	24
60-6790-001	81	81-10-1000	87	16150	24
60-6805-001	52	81-10-4010	87	16160	24
60-6810-001	52	81-10-4100	87	16162	24
60-6815-001	52	400-2100	73	16220	24
60-6827-001A	52	400-2700	73	16911	24
60-6828-001A	52	410-2000	73	16912	24
60-6828-005A	52	410-2100	73	130301A	76
60-6829-001A	52	410-2200	73	130302A	76
60-6829-005A	52	425-2200	73	130303A	76
60-6839-001A	52	425-2508	73	130304A	76
60-6963-001	71	440-2400	73	130307A	76
60-7152-001	71	450-2300	73	130309A	76
60-7510-005	51	530	42	130316	77
60-7520-005	51	1221	37	130317	77
60-7521-001	51	1222	37	130317-15	77
60-7522-001	51	1411	37	130321	75
60-7523-001	51	1412	37	130326A	76
60-7524-001	51	1700	24	130327A	76
60-7526-001	51	1705	24	130342	74
60-7530-005	51	3013	42	130344	74
60-7570-005	51	3013R	42	130345	74

# Product Index

Catalog #	Page #	Catalog #	Page #	Catalog #	Page #
130384.....	77	139321.....	79	BTLD004.....	67
130402.....	77	139330.....	74	BTLDXS04.....	67
130403.....	77	139331.....	74	BV-5X70.....	13
130404.....	77	160636.....	75	BV-5X70-BLD.....	13
130405.....	77	160644.....	75	BV-5X70-CAN.....	13
131307A.....	76	160655.....	75	BV-5X100.....	13
131309A.....	76	160656.....	75	BV-5X100-BLD.....	13
131326A.....	76	853590.....	42	BV-5X100-CAN.....	13
131327A.....	76	873590.....	42	BV-5X150.....	13
134003.....	75	85530101.....	33	BV-5X150-BLD.....	13
134006.....	75	A238.....	80	BV-11X70.....	13
134009.....	75	ADP22X22Y.....	61	BV-11X70-CAN.....	13
137668.....	77	AP5-75.....	16	BV-11X100.....	13
138025.....	78	AP5-75-SILK.....	16	BV-11X100-BLD.....	13
138026.....	78	AP5-100.....	16	BV-11X100-CAN.....	13
138029.....	76	AP5-100-SILK.....	16	BV-11X100-HSS.....	13
138100.....	79	APCi5-75.....	16	BV-11X150.....	13
138101.....	79	APCi5-100.....	16	BV-11X150-BLD.....	13
138102.....	78	ARMSTAND.....	62	BV-11X150-CAN.....	13
138103.....	78	AS-iCART.....	11	BV-12X70.....	13
138104.....	79	AS-iCART-6.....	11	BV-12X70-BLD.....	13
138105.....	78	AS-iCART-6V.....	11	BV-12X70-CAN.....	13
138107.....	79	AS-iCART-V.....	11	BV-12X100.....	13
138108.....	78	AS-iCART-V2R.....	11	BV-12X100-BLD.....	13
138110.....	79	AS-iFS2.....	10	BV-12X100-CAN.....	13
138112.....	79	ASM-EVAC1.....	10	BV-12X100-HSS.....	13
138113.....	79	AV41CHE.....	85	BV-12X150.....	13
138114A.....	76	AV41CMS.....	85	BV-12X150-BLD.....	13
138115A.....	76	AV41CON.....	85	BV-12X150-CAN.....	13
138505-10.....	79	AV41LG.....	85	BV-15X100-BLD.....	13
138506-10.....	79	AV41SIC.....	85	BV-15X100BLS.....	13
138650A.....	76	AV4132.....	85	C3278.....	96
138652A.....	76	AV8541.....	85	C7010.....	15
138659A.....	76	AV8542.....	85	C7104.....	15
138663A.....	52	AVELG51.....	85	C7105.....	15
139025EXT.....	79	AVELG52.....	85	CD004.....	43
139100.....	79	AVELG53.....	85	CD203.....	34
139102.....	79	AVELG53SA.....	85	CD411.....	19
139104EXT.....	79	B210.....	80	CD612.....	18
139105EXT.....	79	BFPF7/8-10.....	65	CD650.....	18
139107.....	79	BILF150.....	66	CD775.....	18
139108.....	79	BILF200.....	66	CD801.....	43
139110EXT.....	79	BLAP100.....	58	CD802.....	43
139112.....	79	BLAP100V.....	58	CD845.....	39
139112EXT.....	79	BSPF_7-8-30.....	68	CD846.....	39

## Product Index

Catalog #	Page #	Catalog #	Page #	Catalog #	Page #
CD849	39	CD5080P-I	19	C-LIL-O-075H	32
CD856	39	CD6300P	17	C-LIL-O-100H	32
CD859	39	CD6350P	17	C-LIL-O-120H	32
CD860	39	CD7008G	18	C-LIL-PC-33	32
CD861	39	CD7010G	18	C-LIL-PN-33	32
CD862	39	CD7012G	18	C-LIL-RS-33	32
CD871	39	CD7100G	17	C-LIL-TU-31	31
CD872	39	CD7150G	17	CMS30	91
CD873	39	CD7308G	17	CMS34	91
CD874	39	CD7435G	18	CMS34-STD	91
CD878	39	CD7465G	18	CMS9000	91
CD1402	19	CD7513G	18	DCCM01	60
CD1404	19	CD7535G	18	DCCOV01	60
CD1405	14	CD7565G	18	DKVV220	47
CD1406	19	CD8185	38	DRS29	85
CD1411	14	CD8190	38	EZLINK01	46, 60
CD1412	14	CD8300	38	FS10004	60
CD1415	14	CD8302	38	GS202K	15
CD1605FH	17	CD8400	38	GS1012	15
CD1606FH	17	CD8450	38	GS1013	15
CD1607	17	C-LIL-33-0	32	GS1016	15
CD1608FH	17	C-LIL-33-30	32	GS1050	15
CD1609	17	C-LIL-BTU-35	33	GS1051	15
CD1609FH	17	C-LIL-C-060	32	GS1052	15
CD1610	17	C-LIL-C-075	32	GS1053	15
CD1610FH	17	C-LIL-C-100	32	GS1054	15
CD1612	17	C-LIL-C-120	32	GS2000	15
CD1612FH	17	C-LIL-CT-33	33	GS2050	15
CD1705	20	C-LIL-H-BP	33	HD1000	95
CD1706	20	C-LIL-H-BP1	31	HD1030	95
CD1708	20	C-LIL-H-RP1	31	HD1044	95
CD1722	20	C-LIL-H-YP1	31	HD5500	95
CD1723	20	C-LIL-H-YP2	31	HD5500XL	95
CD1735	20	C-LIL-IB-FS-35	33	HD5530	95
CD1922	20	C-LIL-IP-2DM-31	31	HD5530XL	95
CD1923	20	C-LIL-IP-2SC-31ST	31	HD5544	95
CD1928	20	C-LIL-IP-AL-31	31	HD5544XL	95
CD1935	20	C-LIL-IP-CL-31	31	iAS5-75LP	10
CD1937	20	C-LIL-IP-FS-31	31	iAS5-100LP	10
CD1940	21	C-LIL-IP-ST-31	31	iAS5-120LP	10
CD1950	21	C-LIL-JH-33	33	iAS8-100LP	10
CD1960	21	C-LIL-KG-33	33	iAS8-120LP	10
CD1961	21	C-LIL-LH-33	33	iAS12-100LPi	10
CD1982	21	C-LIL-NS-31	33	iAS12-120LPi	10
CD3900	52	C-LIL-O-060H	32	iAS12-150	10

# Product Index

Catalog #	Page #	Catalog #	Page #	Catalog #	Page #
iASB5-150 .....	10	PLPRO4520 .....	50	SQ001 .....	33
iASB12-100 .....	10	PLPUL2020 .....	49	SQ-22213 .....	12
iASB12-120 .....	10	PLPUL2520 .....	49	SQ-85601038 .....	12
iCART-BRACKET .....	12	PP010 .....	57	ST10105 .....	54
iFS-2PM .....	12	PP010CS .....	57	T210 .....	80
iFS-BC1 .....	10	PP012SEO .....	58	T229 .....	80
iFS-CON1 .....	12	PRFIL20 .....	64	T229-5M .....	80
iFS-Fuse .....	12	PROTIP420 .....	50	T235 .....	80
iFS-HGSV .....	12	PROTIP520 .....	50	TRS070 .....	29
iFS-HPH2 .....	11	PROTIP620 .....	50	TRS080 .....	29
iFS-HPH3 .....	11	PSFTS05 .....	55	TRS090 .....	29
iFS-HPH4 .....	11	PSWTURBO_AS/220 .....	48	TRS100SB2 .....	29
iFS-HPH120 .....	11	RF10110 .....	56	TRS175SB2 .....	29
iFS-ORING .....	12	RF10112 .....	56	TRS190SB2 .....	29
iFS-SEAL .....	12	RF10210 .....	56	TRS-ROBO-8 .....	29
iFS-SP12 .....	12	RF10512 .....	56	TRS-ROBO-12 .....	29
iFS-SP24 .....	12	RF10705 .....	56	TRS-TV-25 .....	29
iFS-SP36 .....	12	RF12524 .....	56	TRS-VATS-15 .....	29
iFS-SP48 .....	12	RF13810 .....	56	UHD1000 .....	94
iFS-Tower1 .....	11	RF783824 .....	56	UHD1000XL .....	94
iFS-Valve1 .....	11	SB534 .....	30	UHD1030 .....	94
iFS-WC1 .....	11	SB836 .....	30	UHD1030XL .....	94
iFS-WC2 .....	11	SB857 .....	30	UHD1044XL .....	94
IM8000 .....	86	SB936 .....	30	UHD5500 .....	94
IM8120 .....	86	SB957 .....	30	UHD5530 .....	94
IM8121 .....	86	SB979 .....	30	UHD5530XL .....	94
IM8123 .....	86	SB1036 .....	30	UHD5544XL .....	94
LA3010CL4 .....	61	SB1057 .....	30	UPC-R80MD .....	92
LA3010EY10 .....	61	SB1079 .....	30	UPC-R81MD .....	92
LA3010PF10 .....	61	SCG-547 .....	12	UP-DR80MD .....	92
LAPVUE10 .....	59	SEM-EVAC .....	10	USB300 .....	91
LG1050 .....	96	SGQ-545 .....	12	VC220 .....	46
LG1090 .....	96	SGQ-588CE .....	11	VC220NF .....	46
LMD-X310MD .....	90	SGQ-589CE .....	11	VC220P1 .....	46
LS7700 .....	89	SGQ-590CE .....	11	VP1003 .....	98
LS8000 .....	85	SGQ-591CE .....	11	VP1005 .....	98
PA1025 .....	53	SGQ-592CE .....	11	VP1006 .....	98
PA1025CB .....	53	SGQ-593CE .....	11	VP1007 .....	98
PA2010 .....	53	SGQ-594CE .....	12	VP1008 .....	98
PA2010B .....	53	SGQ-595CE .....	12	VP1009 .....	98
PA2010BCB .....	53	SIM-TUB .....	10	VP4826 .....	90
PA2010CB .....	53	SING VSEY .....	64	VP4826C .....	90
PLP2020 .....	49	SING-VSXLTT .....	63	VP4832 .....	90
PLP2520 .....	49	SMLOF50 .....	61	VP4832C .....	90
PLPRO4020 .....	50	SnapEvac20 .....	50	VP4932 .....	90



Catalog #	Page #	Catalog #	Page #
VP8500AV-kit	85	VSXLLT04	63
VP8501	85, 93	VT38S1010	54
VP8520	93	VT78-6	54
VP8525	93	VT10106	54
VP8532	93	VT10206	54
VP8540	93	VT10306	54
VP8565	93	VT10324	54
VP8570	85, 93	VT10405	56
VP8571	85, 93	VT10424	54
VP8572	93	VT10510	54
VP8574	93	VT10524	54
VP8575	93	VT10524-10	54
VP8576	93	VT10610	54
VP8577	93	VT10624	54
VP8578	93	VTESU05	55
VP8580	93	VTEYKIT	54
VP8581	93	VTVIC10	55
VS06T04	63	VTWT206	55
VS12D01	65	VTWT324	55
VS135	46, 65	VTWT424	55
VS353	47, 65	VTWT505	55
VS1352	46, 65	VTWT515	55
VS1354	46, 65	VTWT524	55
VS06001	63	VTWT624	55
VS06002	63	VTWT805	55
VS06004	63	VTWTS10	55
VS35302	47, 65	VueTip10	60
VS35304	47, 65	W220	47
VSEY1-4	64	W220NF	47
VSFT10	60		
VSNEP01	69		
VSNEP04	69		
VSOH001	65		
VSOH002	65		
VSSV301	68		
VSSV302	68		
VSSV304	68		
VSSV505	68		
VSSV50502	68		
VSTR08	69		
VSTR0804	69		
VSVET01	64		
VSXLL02	63		
VSXLL04	63		
VSXLLT02	63		



## Advanced Surgical Product Catalog

[CONMED.com](http://CONMED.com)

[info@mail.CONMED.com](mailto:info@mail.CONMED.com)